

SECTION B-B

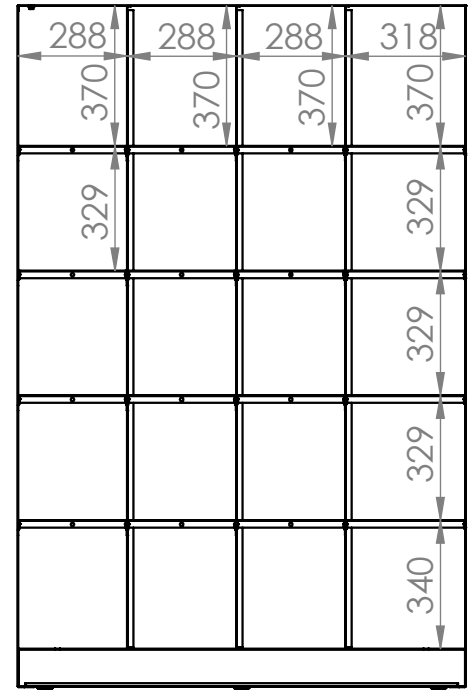

SECTION D-D

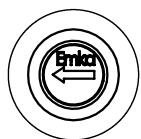
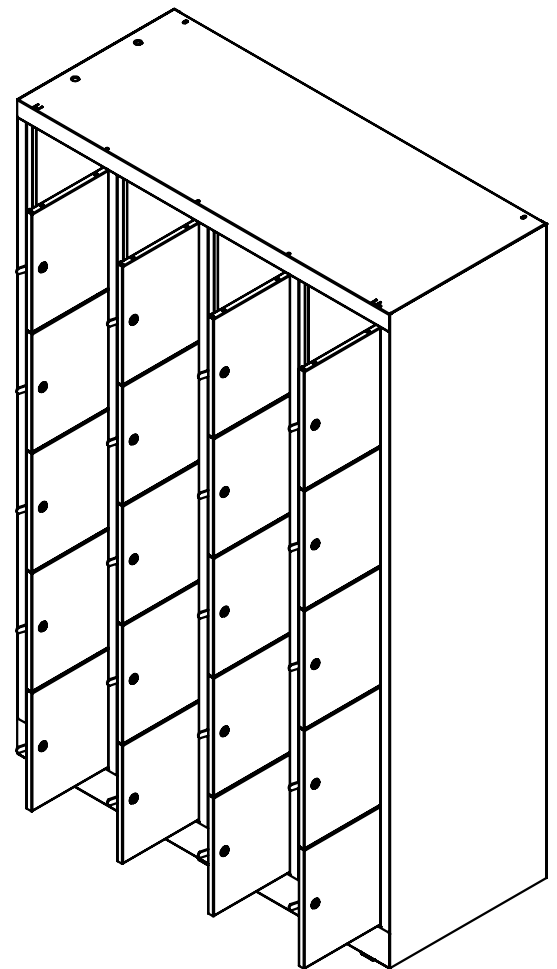
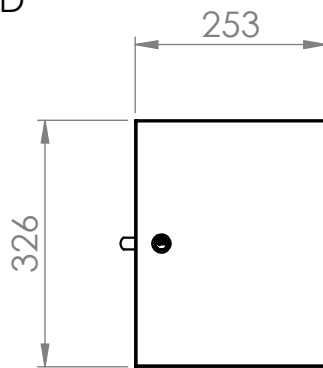
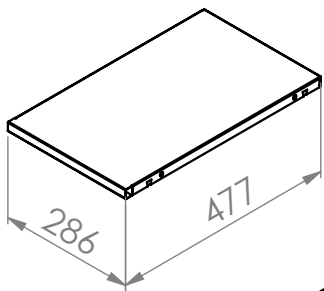
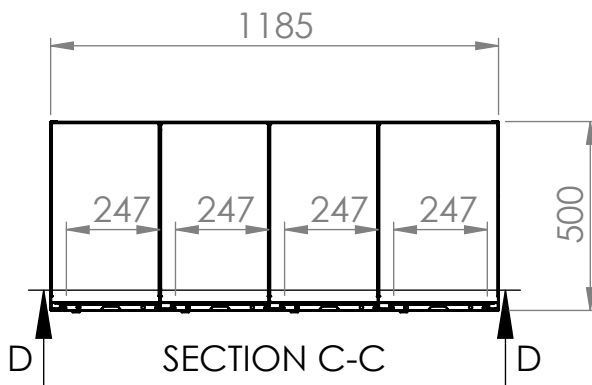

DETAIL E
SCALE 1 : 2

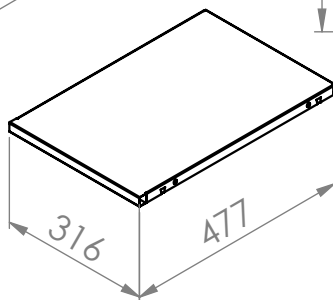

Best.-Nr.: X-520540

ClassiX Schließfachschrank - 4 Abteile - 20 Fächer - H 1800 x B 1185 x T 500 mm