





April 2012						
1	2	3	4	5	6	7
8	9	10	11	12	13	14
15	16	17	18	19	20	21
22	23	24	25	26	27	28
29	30	31				
May 2012						
1	2	3	4	5	6	7
8	9	10	11	12	13	14
15	16	17	18	19	20	21
22	23	24	25	26	27	28
29	30	31				
June 2012						
1	2	3	4	5	6	7
8	9	10	11	12	13	14
15	16	17	18	19	20	21
22	23	24	25	26	27	28
29	30	31				
July 2012						
1	2	3	4	5	6	7
8	9	10	11	12	13	14
15	16	17	18	19	20	21
22	23	24	25	26	27	28
29	30	31				





SCHREIBTISCH HÖHENEINSTELLBAR





Stand 08/2020

O-SERIE

C-Fuß





Arbeitshöhe	65–85 cm
Höhenverstellung	Mechanisch im Raster von 1 cm Höhenjustierung durch Fuß ±5 mm
Fußgestell	Gestell Stahl, pulverbeschichtet - Silber - Graphit Innenblende abnehmbar Vertikale Kabelführung im Tischfuß möglich
Unterbau	Horizontale Kabelwanne
Tischplatte	Stärke 2,5 cm ABS-Dickkante, Kunststoff, gerundet, 2 mm Melaminharzbeschichtete Spanplatten nach DIN 68765, E1 E05 TSCA
Hinweis	Ware zerlegt, einfache Montage

Office

	80 x 80 cm Silber Schwarz Weiß	VOS08/* VOS08/*D VOS08/*W
	120 x 80 cm Silber Schwarz Weiß	VOS12/* VOS12/*D VOS12/*W
	160 x 80 cm Silber Schwarz Weiß	VOS16/* VOS16/*D VOS16/*W
	180 x 80 cm Silber Schwarz Weiß	VOS19/* VOS19/*D VOS19/*W

ZUBEHÖR

Passend zur Serie	Verkürzte Füße VOFUK
Weiteres Zubehör	PC-Halter Bildschirmhalter Knieraumblenden Unterbauschubladen Akustik-Elemente

	200 x 100 cm Silber Schwarz Weiß	VOS2E/* VOS2E/*D VOS2E/*W
	200 x 100 cm Silber Schwarz Weiß	VOS20/* VOS20/*D VOS20/*W
	180 x 100 cm Silber Schwarz Weiß	VOS18/* VOS18/*D VOS18/*W
	200 x 120 cm Silber Schwarz Weiß	VOS82/* VOS82/*D VOS82/*W
	210 x 113 cm Silber Schwarz Weiß	VOS21/* VOS21/*D VOS21/*W

Das sollten Sie wissen

Mobiles Arbeiten

Ob separates Büro oder begrenzte Möglichkeiten in Wohnzimmer, Küche und Schlafzimmer - „Mini Office“-Produkte sind perfekt für das mobile Arbeiten zu Hause.

Homeoffice

Unsere Produkte für den Homeoffice Bereich gemäß Arbeitsstättenverordnung finden Sie in unserer Haupt-Preisliste.

Mini Office

	120 x 67,2 cm Silber Schwarz Weiß	VOS612/* VOS612/*D VOS612/*W
	140 x 67,2 cm Silber Schwarz Weiß	VOS614/* VOS614/*D VOS614/*W

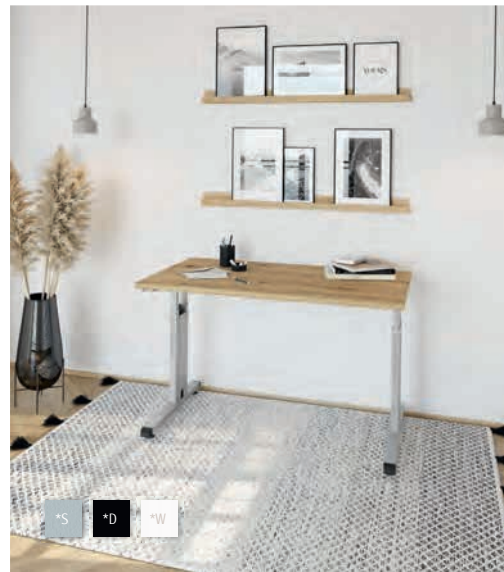
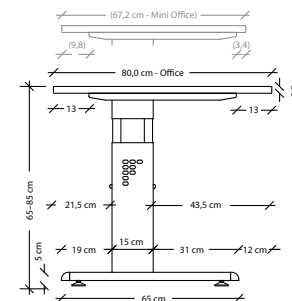

OFFICE						MINI OFFICE	
*3	*5	*6	*N	*W	*E	*W	R

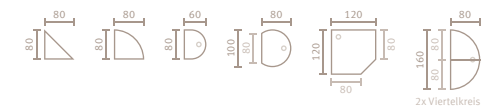







*S

*D

*W

OFFICE

*3

*5

*6

*N

*W

*E

MINI OFFICE

*W

R

O-SERIE

C-Fuß

Arbeitshöhe	65–85 cm
Höhenverstellung	Mechanisch im Raster von 1 cm Höhenjustierung durch Fuß ±5 mm
Fußgestell	Gestell Stahl, pulverbeschichtet - Silber - Graphit Innenblende abnehmbar Vertikale Kabelführung im Tischfuß möglich
Unterbau	Horizontale Kabelwanne
Tischplatte	Stärke 2,5 cm ABS-Dickkante, Kunststoff, gerundet, 2 mm Melaminharzbeschichtete Spanplatten nach DIN 68765, E1 E05 TSCA
Hinweis	Ware zerlegt, einfache Montage

ZUBEHÖR

Passend zur Serie	Verkürzte Füße VOFUK
Weiteres Zubehör	PC-Halter Bildschirmhalter Knierraumbleden Unterbauschubladen Akustik-Elemente

Das sollten Sie wissen

Mobiles Arbeiten

Ob separates Büro oder begrenzte Möglichkeiten in Wohnzimmer, Küche und Schlafzimmer - „Mini Office“-Produkte sind perfekt für das mobile Arbeiten zu Hause.

Homeoffice

Unsere Produkte für den Homeoffice Bereich gemäß Arbeitsstättenverordnung finden Sie in unserer Haupt-Preisliste.

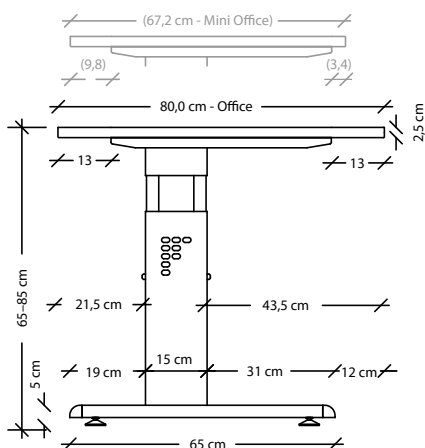

Office

	80 x 80 cm Silber Schwarz Weiß	VOS08/* VOS08/*D VOS08/*W
	120 x 80 cm Silber Schwarz Weiß	VOS12/* VOS12/*D VOS12/*W
	160 x 80 cm Silber Schwarz Weiß	VOS16/* VOS16/*D VOS16/*W
	180 x 80 cm Silber Schwarz Weiß	VOS19/* VOS19/*D VOS19/*W
	200 x 100 cm Silber Schwarz Weiß	VOS2E/* VOS2E/*D VOS2E/*W
	200 x 100 cm Silber Schwarz Weiß	VOS20/* VOS20/*D VOS20/*W
	180 x 100 cm Silber Schwarz Weiß	VOS18/* VOS18/*D VOS18/*W
	200 x 120 cm Silber Schwarz Weiß	VOS82/* VOS82/*D VOS82/*W
	210 x 113 cm Silber Schwarz Weiß	VOS21/* VOS21/*D VOS21/*W

Mini Office

	120 x 67,2 cm Silber Schwarz Weiß	VOS612/* VOS612/*D VOS612/*W
	140 x 67,2 cm Silber Schwarz Weiß	VOS614/* VOS614/*D VOS614/*W

