



Y







SCHREIBTISCH HÖHENEINSTELLBAR

Stand 04/2020

Y-SERIE

4-Fuß

Arbeitshöhe	68–82 cm		80 x 80 cm Silber VYS08/*S Graphit VYS08/*G
Höhenverstellung	Mechanisch mittels Stellschraube im Raster von 1 cm Höhenjustierung durch Fuß ±5 mm		120 x 80 cm Silber VYS12/*S Graphit VYS12/*G
Fußgestell	Gestell Stahl, pulverbeschichtet - Silber (ähnlich RAL 9006) - Graphit 6,0 cm Rundrohr		160 x 80 cm Silber VYS16/*S Graphit VYS16/*G
Unterbau	2 trapezförmige Quertraversen 3 x 6 cm		180 x 80 cm Silber VYS19/*S Graphit VYS19/*G
Tischplatte	Stärke 2,5 cm 2 mm Kunststoff-Kante gerundet Melaminharzbeschichtete Spanplatten nach DIN 68765 E1 E05 TSCA		
Hinweis	Ware zerlegt, einfache Montage		

VERKETTUNGS-/ANBAUPLATTEN

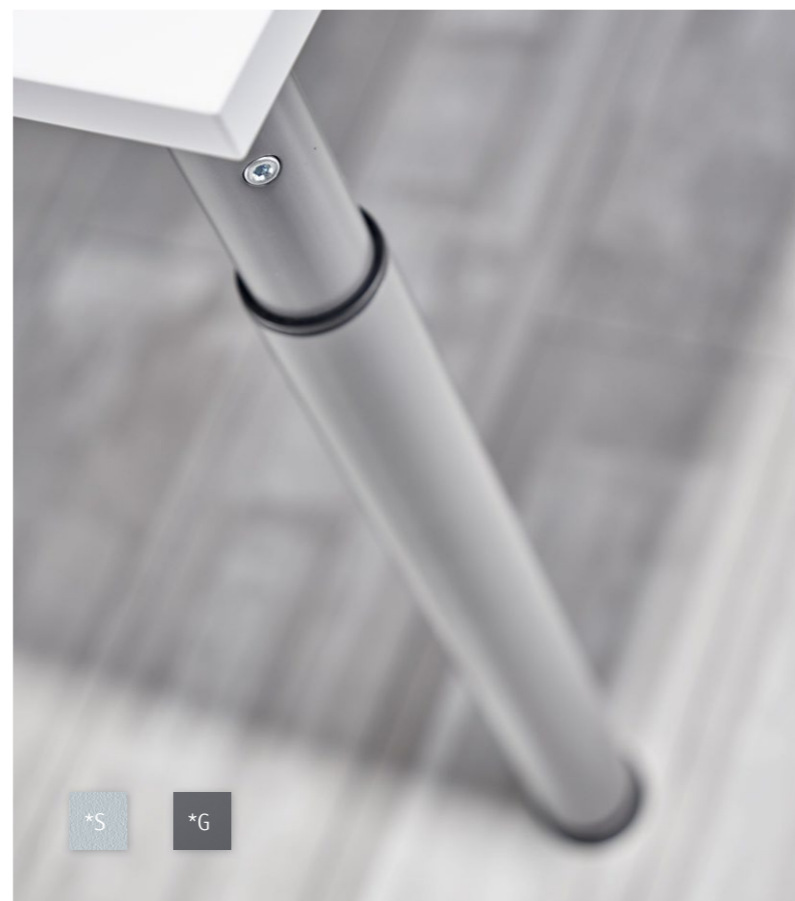
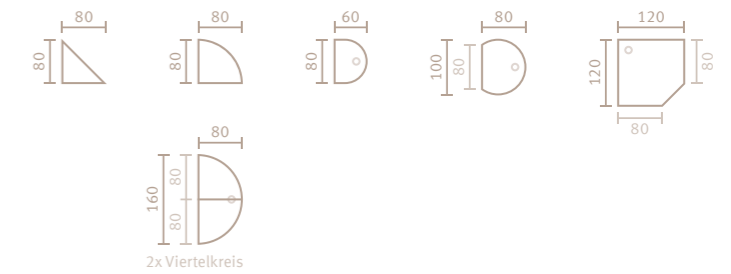

*S *G

*3 *5 *6 *N *W *E *M

ZUBEHÖR

Wir empfehlen	Kabelspirale (vert.) Kabelklemmen	VCKXE VKLEM
Weiteres Zubehör	PC-Halter Bildschirmhalter Kabelwanne Knierraumbleden Unterbauschubladen Akustik-Elemente	

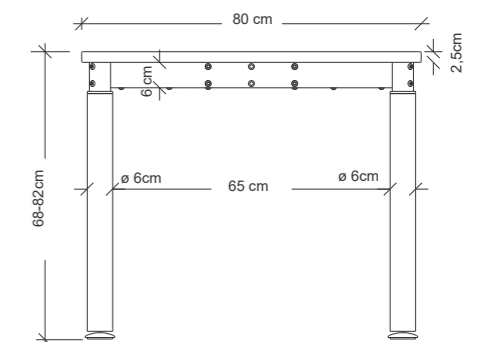

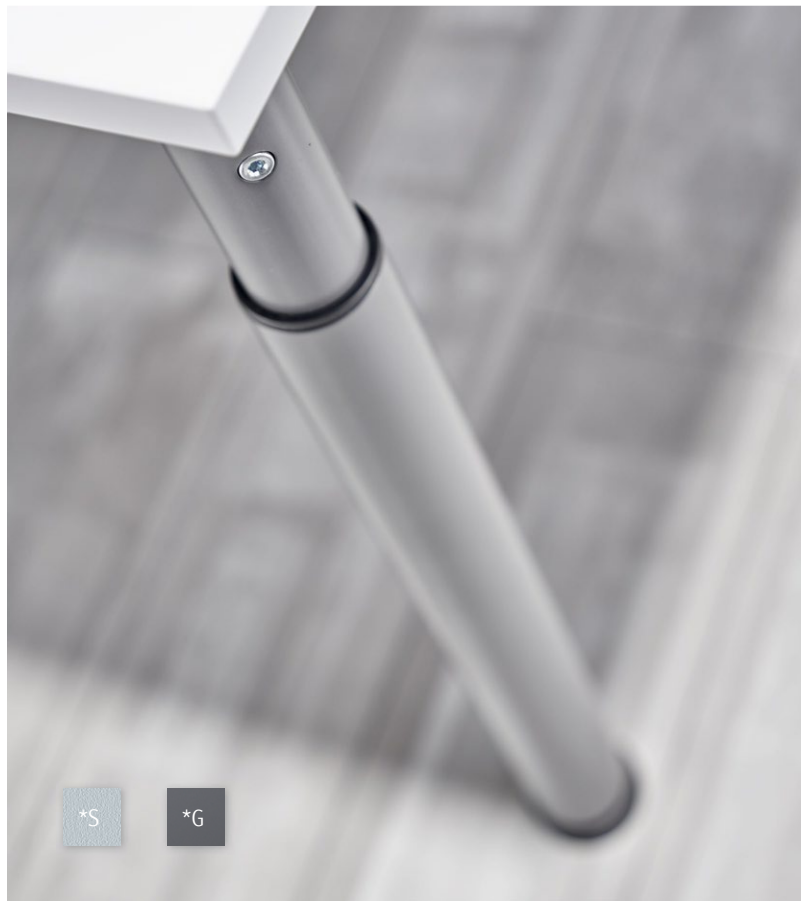
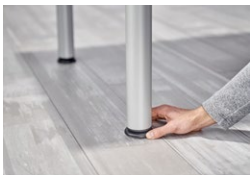

*S

*G

*3

*5

*6

*N

*W

*E

*M

Y-SERIE

4-Fuß

Arbeitshöhe	68–82 cm
Höhenverstellung	Mechanisch mittels Stellschraube im Raster von 1 cm Höhenjustierung durch Fuß ±5 mm
Fußgestell	Gestell Stahl, pulverbeschichtet - Silber (ähnlich RAL 9006) - Graphit 6,0 cm Rundrohr
Unterbau	2 trapezförmige Quertraversen 3 x 6 cm
Tischplatte	Stärke 2,5 cm 2 mm Kunststoff-Kante gerundet Melaminharzbeschichtete Spanplatten nach DIN 68765 E1 E05 TSCA
Hinweis	Ware zerlegt, einfache Montage



80 x 80 cm
Silber VYS08/*/S
Graphit VYS08/*/G



120 x 80 cm
Silber VYS12/*/S
Graphit VYS12/*/G



160 x 80 cm
Silber VYS16/*/S
Graphit VYS16/*/G



180 x 80 cm
Silber VYS19/*/S
Graphit VYS19/*/G

VERKETTUNGS-/ANBAUPLATTEN

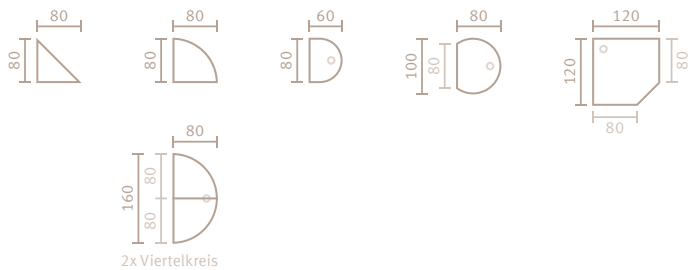

ZUBEHÖR



Wir empfehlen	Kabelspirale (vert.) Kabelklemmen	VCKXE VKLEM
Weiteres Zubehör	PC-Halter Bildschirmhalter Kabelwanne Knieraumblenden Unterbauschubladen Akustik-Elemente	

