



# OREGON®



Stihl™, Husqvarna™, Jonsered™,  
Dolmar™, Echo™, Oleo-Mac™,  
Shindaiwa™, Zenoah™



[infocenter.oregonproducts.eu](http://infocenter.oregonproducts.eu)



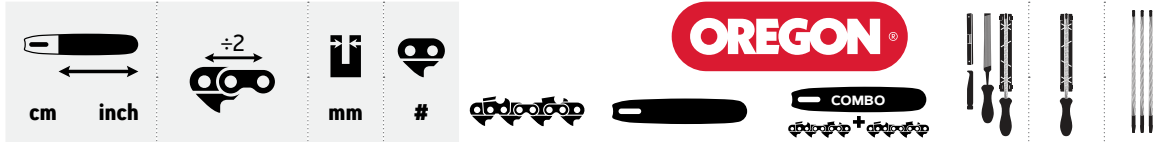

AEG™												
A18CHS14, ACS18B, ACS18B30, ACS18B3060, ACS18BS6	30	12	3/8" LOW PROFILE	1.1	45	A45	124MLEA041			A1	A2	A5
KES35, KS30, KS35, KS40	30	12	3/8" LOW PROFILE	1.3	45	B45	120SDEA041	(1x) 120SDEA041 (2x) 91P045		B1	B2	B5
	35	14	3/8" LOW PROFILE	1.3	52	B52	140SDEA041	(1x) 140SDEA041 (2x) 91P052		B1	B2	B5
ACS58B200, ACS58B400	40	16	3/8" LOW PROFILE	1.3	57	B57	160SDEA041			B1	B2	B5
	40	16	3/8" LOW PROFILE	1.3	56	B56	160SDEA041	(1x) 160SDEA041 (2x) 91P056		B1	B2	B5
A58CHS18, ACS58B18	45	18	3/8" LOW PROFILE	1.3	62	B62	180SDEA041			B1	B2	B5
ALDI™												
Mc.C. 839	40	16	3/8" LOW PROFILE	1.3	54	B54	160SDEA318			B1	B2	B5
AL-KO™												
CS1825	25	10	3/8" LOW PROFILE	1.1	40	A40				A1	A2	A5
CSA1820, CSA2020, CSA4020, MT40	20	8	3/8" LOW PROFILE	1.3	33	B33	080SDEA041			B1	B2	B5
	30	12	3/8" LOW PROFILE	1.3	45	B45	120SDEA041	(1x) 120SDEA041 (2x) 91P045		B1	B2	B5
CS36Li, CS4030	35	14	3/8" LOW PROFILE	1.3	52	B52	140SDEA041	(1x) 140SDEA041 (2x) 91P052		B1	B2	B5
	40	16	3/8" LOW PROFILE	1.3	57	B57	160SDEA041			B1	B2	B5
AC310714-38, AC310716-38, KB35/35	35	14	3/8" LOW PROFILE	1.3	49	B49	140SDEA318			B1	B2	B5
	40	16	3/8" LOW PROFILE	1.3	54		160SDEA318			B1	B2	B5
	45	18	3/8" LOW PROFILE	1.3	60		180SDEA318			B1	B2	B5
KE1800/35, KE1800/40S	35	14	3/8" LOW PROFILE	1.3	50	B50				B1	B2	B5
	40	16	3/8" LOW PROFILE	1.3	55	B55				B1	B2	B5
BKS35, BKS35II, BKS35/35II, BKS40, BKS40II, BKS40/40II, EKI2200-40, EKS2000-35, EKS2400-40	35	14	3/8" LOW PROFILE	1.3	52	B52	140SDEA041	(1x) 140SDEA041 (2x) 91P052		B1	B2	B5
	40	16	3/8" LOW PROFILE	1.3	56	B56	160SDEA041	(1x) 160SDEA041 (2x) 91P056		B1	B2	B5
BKS3835, BKS4040	35	14	3/8" LOW PROFILE	1.3	53	B53	140SDEA041			B1	B2	B5
	40	16	3/8" LOW PROFILE	1.3	57	B57	160SDEA041			B1	B2	B5
ALPINA™												
P34, P34S	30	12	3/8" LOW PROFILE	1.1	44	A44				A1	A2	A5
AMT20LiKit, AMT26, AMT48LiKit, APR25, APR527, A2500, C25, MT2148Li	20	8	3/8" LOW PROFILE	1.3	33	B33	080SDEA041			B1	B2	B5
	25	10	3/8" LOW PROFILE	1.3	40	B40	100SDEA041			B1	B2	B5
ACS40Li, APR48Li	30	12	3/8" LOW PROFILE	1.3	45	B45	120SDEA041	(1x) 120SDEA041 (2x) 91P045		B1	B2	B5



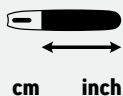

### ALPINA™ ./..

ACS 1.8 E, ACS 180 E, EA 1800	35	14	3/8" LOW PROFILE	1.3	52	<b>B52</b>	<b>140SDEA041</b>	(1x) <b>140SDEA041</b> (2x) <b>91P052</b>	B1	B2	B5
A 375, A 405, A 3700, A 4000, ACS 38, ACS 531, ACS 538, A180 E, A200 E, A200 EQ, A350, A350Q, A400, A400 Q, A3700, ACS 38, ACS 38T, C1.8E H33, C1.8ET, C2.0E, C2.0ET, C 38, C 38 T, CP 38, CP 40, P352, P338, SP 375, SP 375Q, XC 238, XC 240	30	12	3/8" LOW PROFILE	1.3	45	<b>B45</b>	<b>120SDEA041</b>	(1x) <b>120SDEA041</b> (2x) <b>91P045</b>	B1	B2	B5
	35	14	3/8" LOW PROFILE	1.3	53	<b>B53</b>	<b>140SDEA041</b>		B1	B2	B5
	40	16	3/8" LOW PROFILE	1.3	57	<b>B57</b>	<b>160SDEA041</b>		B1	B2	B5
A-10E, A-14E, ACS 1.8 E, ACS 2.0 ET, ACS 2.2 ET, E120, E130, E150, EA 1800, EA 2000 Q, KS 1400B, KS 1500B	35	14	3/8" LOW PROFILE	1.3	52	<b>B52</b>	<b>140SDEA041</b>	(1x) <b>140SDEA041</b> (2x) <b>91P052</b>	B1	B2	B5
	40	16	3/8" LOW PROFILE	1.3	57	<b>B57</b>	<b>160SDEA041</b>		B1	B2	B5
ACS 200 ET	40	16	3/8" LOW PROFILE	1.3	56	<b>B56</b>	<b>160SDEA041</b>	(1x) <b>160SDEA041</b> (2x) <b>91P056</b>	B1	B2	B5
ACS 41, ACS 41T, ACS 542, C 41, C 41T, SP 405, SP 405Q	33	13	.325"	1.3	56	<b>D56</b>	<b>130MLBK041</b>		D1	D2	D5
	38	15	.325"	1.3	64	<b>D64</b>	<b>150MLBK041</b>		D1	D2	D5
	40	16	.325"	1.3	66	<b>D66</b>	<b>160MLBK041</b>		D1	D2	D5
	33	13	.325"	1.5	56	<b>F56</b>	<b>138PXBK095</b>	(1x) <b>138PXBK095</b> (2x) <b>21BPX056</b>	D1	D2	D5
	38	15	.325"	1.5	64	<b>F64</b>	<b>158PXBK095</b>	(1x) <b>158PXBK095</b> (2x) <b>21BPX064</b>	D1	D2	D5
A 455, A 4500, ACS 46, ACS 50, ACS 546, ACS 552, C 46, CP 45, MC 846, XC 246, C 50	40	16	.325"	1.5	66	<b>F66</b>	<b>168PXBK095</b>		D1	D2	D5
	45	18	.325"	1.5	72	<b>F72</b>	<b>188PXBK095</b>	(1x) <b>188SFGK095</b> (2x) <b>21BPX072</b>	D1	D2	D5
	50	20	.325"	1.5	78	<b>F78</b>	<b>208PXBK095</b>		D1	D2	D5
P660, P680, P700, P750, P800, Prof-700, Prof-750, Prof-800	45	18	3/8"	1.5	68	<b>L68</b>	<b>188SFHD009</b>	(1x) <b>188SFHD009</b> (2x) <b>73DPX068</b>	K1	K2	K5
	50	20	3/8"	1.5	72	<b>L72</b>	<b>208SFHD009</b>	(1x) <b>208SFHD009</b> (2x) <b>73DPX072</b>	K1	K2	K5

### ASGATEC™

EK1400, EK1600, EK1801, EK1840, EK2001, EK2040	35	14	3/8" LOW PROFILE	1.3	52	<b>B52</b>	<b>140SDEA041</b>	(1x) <b>140SDEA041</b> (2x) <b>91P052</b>	B1	B2	B5
	40	16	3/8" LOW PROFILE	1.3	57	<b>B57</b>	<b>160SDEA041</b>		B1	B2	B5

### ATIKA™

KSH 600, KSH 710 SDS, KSHC 40-20	20	8	3/8" LOW PROFILE	1.1	33	<b>A33</b>			A1	A2	A5
BKSH 30, BMGS 30	25	10	3/8" LOW PROFILE	1.3	40	<b>B40</b>			B1	B2	B5
KS 1800/35, KSC 40-35	35	14	3/8" LOW PROFILE	1.3	52	<b>B52</b>			B1	B2	B5
KS 2403/40	40	16	3/8" LOW PROFILE	1.3	56	<b>B56</b>			B1	B2	B5
BKS38, BKS 38A, Comet KS200/40, KS 2000/40	40	16	3/8" LOW PROFILE	1.3	57	<b>B57</b>	<b>160SDEA041</b>		B1	B2	B5

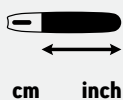

### ATIKA™ ./.

KS 2001/40, KS 2002/40, KS 2201/40, KSC 2401/40, KS 2402/40, KSL 2200/40, KSL 2401/40, O.K. BKS 40	40	16	3/8" LOW PROFILE	1.3	57	<b>B57</b>		B1	B2	B5
BKS 45-2	45	18	.325"	1.5	72	<b>F72</b>		D1	D2	D5

### B&Q™

FPCSP38-1	35	14	3/8" LOW PROFILE	1.3	52	<b>B52</b>		B1	B2	B5
FPCSP45	40	16	3/8" LOW PROFILE	1.3	55	<b>B55</b>	<b>160SDEA095</b>	B1	B2	B5

### BASIC™

EKS 1800	40	16	3/8" LOW PROFILE	1.3	54		<b>160SDEA318</b>	B1	B2	B5
EK1800, EKS 1800-2, MKS4640	40	16	3/8" LOW PROFILE	1.3	57	<b>B57</b>	<b>160SDEA041</b> (1x) <b>160SDEA041</b> (2x) <b>91P056</b>	B1	B2	B5

### BESTGREEN™

BG2525	25	10	3/8" LOW PROFILE	1.3	40	<b>B40</b>	<b>100SDEA041</b>	B1	B2	B5
BG EXPERT 2730	30	12	3/8" LOW PROFILE	1.3	45	<b>B45</b>	<b>120SDEA041</b> (1x) <b>120SDEA041</b> (2x) <b>91P045</b>	B1	B2	B5
BG1900T, BG4245, BG ECS2000	40	16	3/8" LOW PROFILE	1.3	56	<b>B56</b>	<b>160SDEA041</b> (1x) <b>160SDEA041</b> (2x) <b>91P056</b>	B1	B2	B5
BG EXPERT CS2400, BG4040	40	16	3/8" LOW PROFILE	1.3	57	<b>B57</b>	<b>160SDEA041</b>	B1	B2	B5
BG4445	45	18	.325"	1.3	72	<b>E72</b>		D1	D2	D5
BG3840	40	16	.325"	1.5	66	<b>F66</b>		D1	D2	D5
BG EXPERT 4545	45	18	.325"	1.5	72	<b>F72</b>	<b>188PXBK095</b> (1x) <b>188SFGK095</b> (2x) <b>21BPX072</b>	D1	D2	D5
BG EXPERT 5050	50	20	.325"	1.5	78	<b>F78</b>	<b>208PXBK095</b>	D1	D2	D5

### BILTEMA™

CS122G	30	12	3/8" LOW PROFILE	1.3	45	<b>B45</b>	<b>120SDEA041</b> (1x) <b>120SDEA041</b> (2x) <b>91P045</b>	B1	B2	B5
17-431 (40cc)	35	14	3/8" LOW PROFILE	1.3	52	<b>B52</b>	<b>140SDEA041</b> (1x) <b>140SDEA041</b> (2x) <b>91P052</b>	B1	B2	B5
CS142G	35	14	3/8" LOW PROFILE	1.3	53	<b>B53</b>	<b>140SDEA041</b>	B1	B2	B5
17-437 (50cc)	40	16	3/8" LOW PROFILE	1.3	56	<b>B56</b>	<b>160SDEA095</b>	B1	B2	B5
17-4323 EL	40	16	3/8" LOW PROFILE	1.3	57	<b>B57</b>	<b>160SDEA041</b>	B1	B2	B5
	33	13	.325"	1.5	56	<b>F56</b>	<b>138PXBK041</b>	D1	D2	D5
CS162G	38	15	.325"	1.5	64	<b>F64</b>	<b>158PXBK041</b>	D1	D2	D5
	40	16	.325"	1.5	66	<b>F66</b>	<b>168PXBK041</b>	D1	D2	D5

### BLACK + DECKER™

GK1817, GKC1817, GPC1800, GPC1820, GPC1820L20, LPP120	20	8	3/8" LOW PROFILE	1.1	34	<b>90PX034E</b>		A1	A2	A5
GKC3630L20, GKC3630LB	30	12	3/8" LOW PROFILE	1.1	45	<b>A45</b>	<b>124MLEA041</b>	A1	A2	A5



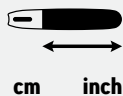

### BLACK + DECKER™ ./..

GKC1825LB, GKC1825L20, PP610, PS7525	25	10	3/8" LOW PROFILE	1.3	40	<b>B40</b>	<b>100SDEA041</b>		B1	B2	B5
CS30, CS35, DN400, DN401, DN402, DN404, DN412, DN416, GK30, GK35, GK120, GK300, GK310, GK320, GK321, GK322, GK330, GK331, GK425, GK430, GK435, GK440, GK534, GK535, GK540, GK1365, GK1430, GK1435, GK1440, GK1630, GK1630T, GK1635, GK1635TX, GK1635T, GK1640, GK1640T, GK1935, GK1940	30	12	3/8" LOW PROFILE	1.3	44	<b>B44</b>	<b>120SDEA318</b>		B1	B2	B5
	35	14	3/8" LOW PROFILE	1.3	49	<b>B49</b>	<b>140SDEA318</b>		B1	B2	B5
	40	16	3/8" LOW PROFILE	1.3	56	<b>B56</b>	<b>160SDEA318</b>		B1	B2	B5
GK1635TX-QS	35	14	3/8" LOW PROFILE	1.3	49	<b>B49</b>			B1	B2	B5
CS1835	35	14	3/8" LOW PROFILE	1.3	52	<b>B52</b>			B1	B2	B5
GK1640T	40	16	3/8" LOW PROFILE	1.3	56	<b>B56</b>			B1	B2	B5
BDC20, CS1840, CS2040, GK1940T, GK2240T, GK2240TX	40	16	3/8" LOW PROFILE	1.3	57	<b>B57</b>			B1	B2	B5
CS2245	45	18	3/8" LOW PROFILE	1.3	62	<b>B62</b>	<b>180SDEA041</b>		B1	B2	B5

### BLACKLINE™

BL-BK35/2	35	14	3/8" LOW PROFILE	1.3	53	<b>B53</b>			B1	B2	B5
-----------	----	----	------------------	-----	----	------------	--	--	----	----	----

### BONUS™

KSB35, MKS3835, GK1635TE	35	14	3/8" LOW PROFILE	1.3	49	<b>B49</b>			B1	B2	B5
KSi1800-35, KSi1800	35	14	3/8" LOW PROFILE	1.3	52	<b>B52</b>	<b>140SDEA041</b>	(1x) <b>140SDEA041</b>	B1	B2	B5
	40	16	3/8" LOW PROFILE	1.3	57	<b>B57</b>	<b>160SDEA041</b>	(2x) <b>91P052</b>	B1	B2	B5
EKS2500QT	40	16	3/8" LOW PROFILE	1.3	55	<b>B55</b>			B1	B2	B5
KSE2000S	40	16	3/8" LOW PROFILE	1.3	55	<b>B55</b>	<b>160SDEA318</b>		B1	B2	B5

### BOSCH™

UniversalChainPole 18, UniversalChain 18	20	8	3/8" LOW PROFILE	1.1	33	<b>A33</b>	<b>084MLEA041</b>		A1	A2	A5
AdvancedChain 36V-35-40 (06008B8600), AKE30Li*, AKE30S, AKE30/17S, AKE30/18S, AKE30-19S, AKE35, AKE35S, AKE35/17S, AKE35/18S, AKE35/19, AKE35/19S, AKE35S/19S, AKE36S, AKE40*, AKE40S*, AKE40SDS, AKE40/17S, AKE40/18S, AKE40/19S*, AKE3000*, AKE3500E*, AKE4000*, 35-19S, 40-19S, 40-19PRO, 35 Uni, Universal 35, UniversalChain 35, UniversalChain 40, Akkusäge 30Li	30	12	3/8" LOW PROFILE	1.1	45	<b>A45</b>	<b>124MLEA041</b>		A1	A2	A5
	35	14	3/8" LOW PROFILE	1.1	52	<b>A52</b>	<b>144MLEA041</b>		A1	A2	A5
	40	16	3/8" LOW PROFILE	1.1	56	<b>A56</b>	<b>164MLEA041</b>		A1	A2	A5

\*Gauge may vary and be 1.3mm

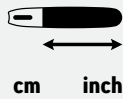
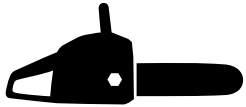

### BOSCH™ /./.

1586.7, 1586.8, AKE30B, AKE30Li*, AKE30-19Pro, AKE35-19Pro, AKE35B, AKE40-19Pro, AKE40*, AKE40B, AKE40S*, AKE40-19S*, AKE3000*, AKE3500*, AKE4000*, AKE Edition, BKE30, GKE35B, GKE35BC, GKE35BCE, GKE40BC, GKE40BCE	30	12	3/8" LOW PROFILE	1.3	45	<b>B45</b>	<b>120SDEA041</b>	(1x) <b>120SDEA041</b> (2x) <b>91P045</b>	B1	B2	B5
PKE25, PKE30B, PKE35B, PKE40B, PKE40	35	14	3/8" LOW PROFILE	1.3	52	<b>B52</b>	<b>140SDEA041</b>	(1x) <b>140SDEA041</b> (2x) <b>91P052</b>	B1	B2	B5
* Gauge may vary and be 1.1mm	40	16	3/8" LOW PROFILE	1.3	56	<b>B56</b>	<b>160SDEA041</b>	(1x) <b>160SDEA041</b> (2x) <b>91P056</b>	B1	B2	B5
AKE45S	40	16	3/8" LOW PROFILE	1.3	57	<b>B57</b>			B1	B2	B5
	45	18	3/8" LOW PROFILE	1.3	62	<b>B62</b>	<b>180SDEA041</b>		B1	B2	B5

### BRICOMARCHE™

CSP2525	25	10	3/8" LOW PROFILE	1.3	40	<b>B40</b>	<b>100SDEA041</b>		B1	B2	B5
MSF-4300-1	25	10	3/8" LOW PROFILE	1.3	40	<b>B40</b>			B1	B2	B5

### BUDGET™

BKS1600	35	14	3/8" LOW PROFILE	1.3	52	<b>B52</b>			B1	B2	B5
BKS 402	40	16	3/8" LOW PROFILE	1.3	56	<b>B56</b>			B1	B2	B5
BKS 401	40	16	3/8" LOW PROFILE	1.3	57	<b>B57</b>			B1	B2	B5

### BULLCRAFT™

KSE30, KS300, KS1300B, BES1300B, KS40S, KS400S, KSE1300B	30	12	3/8" LOW PROFILE	1.3	44	<b>B44</b>	<b>120SDEA318</b>		B1	B2	B5
	35	14	3/8" LOW PROFILE	1.3	49	<b>B49</b>	<b>140SDEA318</b>		B1	B2	B5
	40	16	3/8" LOW PROFILE	1.3	55	<b>B55</b>	<b>160SDEA318</b>		B1	B2	B5

### CARREFOUR™

9097-31C005	35	14	3/8" LOW PROFILE	1.3	52	<b>B52</b>			B1	B2	B5
-------------	----	----	------------------	-----	----	------------	--	--	----	----	----

### CASTORAMA™

FPPS710	20	8	3/8" LOW PROFILE	1.3	33	<b>B33</b>	<b>080SDEA041</b>		B1	B2	B5
FPCSP25-1, FPCSP25-3	25	10	3/8" LOW PROFILE	1.3	40	<b>B40</b>	<b>100SDEA041</b>		B1	B2	B5
FPCS1800A, FPCSP38, FPCSP38-1	35	14	3/8" LOW PROFILE	1.3	52	<b>B52</b>	<b>140SDEA041</b>	(1x) <b>140SDEA041</b> (2x) <b>91P052</b>	B1	B2	B5
FPCSP41-3	35	14	3/8" LOW PROFILE	1.3	53	<b>B53</b>	<b>140SDEA041</b>		B1	B2	B5
FPCSP45	40	16	3/8" LOW PROFILE	1.3	55	<b>B55</b>	<b>160SDEA095</b>		B1	B2	B5
Cast TPE 40, Inline FPCS2000	40	16	3/8" LOW PROFILE	1.3	56	<b>B56</b>	<b>160SDEA041</b>	(1x) <b>160SDEA041</b> (2x) <b>91P056</b>	B1	B2	B5

### CHAMPION™

138/242/335-16	40	16	3/8" LOW PROFILE	1.3	56	<b>B56</b>			B1	B2	B5
----------------	----	----	------------------	-----	----	------------	--	--	----	----	----

### CMI™

CMI25ccm	30	12	3/8" LOW PROFILE	1.3	45	<b>B45</b>	<b>120SDEA041</b>	(1x) <b>120SDEA041</b> (2x) <b>91P045</b>	B1	B2	B5
CMI1800, EKS-1800, C-EKS-1800/35	35	14	3/8" LOW PROFILE	1.3	52	<b>B52</b>	<b>140SDEA041</b>	(1x) <b>140SDEA041</b> (2x) <b>91P052</b>	B1	B2	B5
CMI38	40	16	3/8" LOW PROFILE	1.3	56	<b>B56</b>	<b>160SDEA041</b>	(1x) <b>160SDEA041</b> (2x) <b>91P056</b>	B1	B2	B5
CMI 45-40	40	16	3/8" LOW PROFILE	1.3	57	<b>B57</b>			B1	B2	B5
2040KSS, C-BKS 45, 4-40, C-BUS 38, CMI 45-40	40	16	3/8" LOW PROFILE	1.3	57	<b>B57</b>	<b>160SDEA041</b>		B1	B2	B5



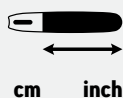

**OREGON**®

COMET™											
CKS200, KS2000/40	40	16	3/8" LOW PROFILE	1.3	57	<b>B57</b>	<b>160SDEA041</b>		B1	B2	B5
CRAMER™											
82CS15	30	12	3/8" LOW PROFILE	1.1	45	<b>A45</b>	<b>124MLEA041</b>		A1	A2	A5
40CS12	35	14	3/8" LOW PROFILE	1.1	52	<b>A52</b>	<b>144MLEA041</b>		A1	A2	A5
40CS15	40	16	3/8" LOW PROFILE	1.1	56	<b>A56</b>	<b>164MLEA041</b>		A1	A2	A5
40PS	20	8	3/8" LOW PROFILE	1.3	33	<b>B33</b>			B1	B2	B5
82CS25	33	13	.325"	1.3	56	<b>D56</b>	<b>130MLBK041</b>		D1	D2	D5
	38	15	.325"	1.3	64	<b>D64</b>	<b>150MLBK041</b>		D1	D2	D5
CUB CADET™											
CC1936, CC2740	35	14	3/8" LOW PROFILE	1.3	52	<b>B52</b>	<b>140SDEA095</b>		B1	B2	B5
	40	16	3/8" LOW PROFILE	1.3	56	<b>B56</b>	<b>160SDEA095</b>		B1	B2	B5
CC3045, 3352, 3551, 4051, 4256	33	13	.325"	1.5	56	<b>F56</b>	<b>138PXBK095</b> (2x) <b>21BPX056</b>	(1x) <b>138PXBK095</b> (2x) <b>21BPX056</b>	D1	D2	D5
	38	15	.325"	1.5	64	<b>F64</b>	<b>158PXBK095</b> (2x) <b>21BPX064</b>	(1x) <b>158PXBK095</b> (2x) <b>21BPX064</b>	D1	D2	D5
	40	16	.325"	1.5	60		<b>168PXBK095</b>		D1	D2	D5
	45	18	.325"	1.5	72	<b>F72</b>	<b>188PXBK095</b> (2x) <b>21BPX072</b>	(1x) <b>188SFGK095</b> (2x) <b>21BPX072</b>	D1	D2	D5
DEWALT™											
DCM565	30	12	3/8" LOW PROFILE	1.1	45	<b>A45</b>	<b>124MLEA041</b>		A1	A2	A5
DCM575N, DCM575X1	40	16	3/8" LOW PROFILE	1.1	56	<b>A56</b>	<b>164MLEA041</b>		A1	A2	A5
DO IT™											
CSE2040/code78203, YD-KY03-38A, YD-KY05-38A	40	16	3/8" LOW PROFILE	1.3	56	<b>B56</b>			B1	B2	B5
DOLMAR™											
AS1925Z, AS1925CZ, AS1925RF, AS1925RT2, AS-3731, AS3835, AS3835Z, AS3935Z, AS4030, ES-2, ES-2A, ES-4 A, ES-4A QS, ES-5 A, ES-5A QS, ES-31A, ES-31, ES-32A QS, ES-33A, ES-34 TLC, ES-36A, ES-37 A, ES-37A QS, ES-38A, ES-39 TLC, ES-40A, ES-41A QS, ES-43 TLC, PS-2, PS-3, PS-4, PS-32*, PS-32C*, PS-32 C TLC*, PS-34, PS-36, PS-38A, PS-34*, PS35, PS-45*	30	12	3/8" LOW PROFILE	1.1	46	<b>A46</b>	<b>124MLEA041</b>		A1	A2	A5
	35	14	3/8" LOW PROFILE	1.1	52	<b>A52</b>	<b>144MLEA041</b>		A1	A2	A5
*Gauge may vary	40	16	3/8" LOW PROFILE	1.1	56	<b>A56</b>	<b>164MLEA041</b>		A1	A2	A5
Pole Saw EE-150, Pole Saw ME-246-4, PS-CS1(199930-1)	25	10	3/8" LOW PROFILE	1.3	39	<b>91PX039E</b>	<b>100SDEA218</b>		B1	B2	B5
AS3626, AS3626LGE, AS3726, PS220TH, PS221TH, PS222TH*, PS311TB25, PS311TH30	25	10	3/8" LOW PROFILE	1.3	40	<b>B40</b>	<b>100SDEA041</b>		B1	B2	B5
*Pitch may vary											

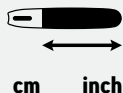

## DOLMAR™ ./..

100, 100S, 101, 102, 103, 104, 105*, 106, 108*, 275, 285, 290, 295, AS4030ZB, AS4035ZB, ES-3, ES-6 A, ES-6A QS, ES-30, ES-35, ES-40 A, ES-41A QS, ES-42 A, ES-43 TLC, ES-140, ES-151A, ES-152A, ES-152 A QS, ES-153 A, ES-160, ES-161A, ES-162A, ES-162A QS, ES-163A, ES-164 TLC, ES-171A, ES-172A, ES-172A QS, ES-173A, ES-174 TLC, ES-183A, ES-1600, ES-2035A, ES-2035AP, ES-2040A, ES-2130 A, ES-2135A, ES-2135 AP, ES-2136 TLC, ES-2140 A, ES-2140 AP, ES-2141 TLC, ES-2141KTLC, PS-2, PS-32*, PS-32 C*, PS-32 C TLC*, PS32C35*, PS33, PS-34*, PS-34S*, PS-35, PS-35 C, PS-35 C TLC, PS35C35, PS35CTLC35, PS-39, PS-39ES, PS41, PS-41 QS, PS-45*, PS-45 QS, PS-330, PS-330 QS, PS-340, PS-340 QS, PS-341, PS-341 Happy Start, PS-344, PS-350, PS-350 C, PS-350 SC, PS350SC35, PS-352, PS352-35, PS352TLC35, PS-390, PS-390 QS, PS-400, PS-400 QS, PS-401, PS-401 QS Happy Start, PS420SC40, PS-3300TH, PS-3400TH, PS-3410, PS-3410 TH, PS-3410 TH TLC, PS-3410TH30 *Pitch and gauge may vary	30	12	3/8" LOW PROFILE	1.3	46	<b>B46</b>	<b>120SDEA041</b>		B1	B2	B5
ES-2035A, ES-2035AP, ES-2040A, ES-2130 A, ES-2135A, ES-2135 AP, ES-2136 TLC, ES-2140 A, ES-2140 AP, ES-2141 TLC, ES-2141KTLC, PS-2, PS-32*, PS-32 C*, PS-32 C TLC*, PS32C35*, PS33, PS-34*, PS-34S*, PS-35, PS-35 C, PS-35 C TLC, PS35C35, PS35CTLC35, PS-39, PS-39ES, PS41, PS-41 QS, PS-45*, PS-45 QS, PS-330, PS-330 QS, PS-340, PS-340 QS, PS-341, PS-341 Happy Start, PS-344, PS-350, PS-350 C, PS-350 SC, PS350SC35, PS-352, PS352-35, PS352TLC35, PS-390, PS-390 QS, PS-400, PS-400 QS, PS-401, PS-401 QS Happy Start, PS420SC40, PS-3300TH, PS-3400TH, PS-3410, PS-3410 TH, PS-3410 TH TLC, PS-3410TH30 *Pitch and gauge may vary	35	14	3/8" LOW PROFILE	1.3	52	<b>B52</b>	<b>140SDEA041</b> (1x) <b>140SDEA041</b> (2x) <b>91P052</b>		B1	B2	B5
PS-39ES, PS41, PS-41 QS, PS-45*, PS-45 QS, PS-330, PS-330 QS, PS-340, PS-340 QS, PS-341, PS-341 Happy Start, PS-344, PS-350, PS-350 C, PS-350 SC, PS350SC35, PS-352, PS352-35, PS352TLC35, PS-390, PS-390 QS, PS-400, PS-400 QS, PS-401, PS-401 QS Happy Start, PS420SC40, PS-3300TH, PS-3400TH, PS-3410, PS-3410 TH, PS-3410 TH TLC, PS-3410TH30 *Pitch and gauge may vary	40	16	3/8" LOW PROFILE	1.3	56	<b>B56</b>	<b>160SDEA041</b> (1x) <b>160SDEA041</b> (2x) <b>91P056</b>		B1	B2	B5
PS-410, PS-411, PS-420, PS-420 C, PS-420 SC, PS420SC38, PS420SCKIT38 *Pitch & motor mount may vary	45	18	3/8" LOW PROFILE	1.3	62	<b>B62</b>	<b>180SDEA041</b>		B1	B2	B5
PS-410, PS-411, PS-420, PS-420 C, PS-420 SC, PS420SC38, PS420SCKIT38 *Pitch & motor mount may vary	33	13	.325"	1.3	56	<b>D56</b>	<b>130MLBK041</b>		D1	D2	D5
PS-410, PS-411, PS-420, PS-420 C, PS-420 SC, PS420SC38, PS420SCKIT38 *Pitch & motor mount may vary	38	15	.325"	1.3	64	<b>D64</b>	<b>150MLBK041</b>		D1	D2	D5
PS-410, PS-411, PS-420, PS-420 C, PS-420 SC, PS420SC38, PS420SCKIT38 *Pitch & motor mount may vary	45	18	.325"	1.3	72	<b>D72</b>	<b>180MLBK041</b>		D1	D2	D5
105*, 108*, 110*, 110i, 110iH, 111*, 115*, 115i, ES-1800, PS-460*, PS-500*, PS-500 C*, PS-550*, PS550-38*, PS-4600*, PS-4600S*, PS-4600 SH, PS-4605*, PS-4605 H*, PS-5000*, PS-5000H, PS-5105*, PS-5105 C*, PS-5105 H, PS-5105 CH*, PS-5105CX*, PS-6100*, PS-6100 H *Pitch & motor mount may vary	33	13	.325"	1.5	56	<b>F56</b>	<b>138PXBK095</b> (1x) <b>138PXBK095</b> (2x) <b>21BPX056</b>		D1	D2	D5
105*, 108*, 110*, 110i, 110iH, 111*, 115*, 115i, ES-1800, PS-460*, PS-500*, PS-500 C*, PS-550*, PS550-38*, PS-4600*, PS-4600S*, PS-4600 SH, PS-4605*, PS-4605 H*, PS-5000*, PS-5000H, PS-5105*, PS-5105 C*, PS-5105 H, PS-5105 CH*, PS-5105CX*, PS-6100*, PS-6100 H *Pitch & motor mount may vary	38	15	.325"	1.5	64	<b>F64</b>	<b>158PXBK095</b> (1x) <b>158PXBK095</b> (2x) <b>21BPX064</b>		D1	D2	D5
105*, 108*, 110*, 110i, 110iH, 111*, 115*, 115i, ES-1800, PS-460*, PS-500*, PS-500 C*, PS-550*, PS550-38*, PS-4600*, PS-4600S*, PS-4600 SH, PS-4605*, PS-4605 H*, PS-5000*, PS-5000H, PS-5105*, PS-5105 C*, PS-5105 H, PS-5105 CH*, PS-5105CX*, PS-6100*, PS-6100 H *Pitch & motor mount may vary	40	16	.325"	1.5	66	<b>F66</b>	<b>168PXBK095</b>		D1	D2	D5
105*, 108*, 110*, 110i, 110iH, 111*, 115*, 115i, ES-1800, PS-460*, PS-500*, PS-500 C*, PS-550*, PS550-38*, PS-4600*, PS-4600S*, PS-4600 SH, PS-4605*, PS-4605 H*, PS-5000*, PS-5000H, PS-5105*, PS-5105 C*, PS-5105 H, PS-5105 CH*, PS-5105CX*, PS-6100*, PS-6100 H *Pitch & motor mount may vary	45	18	.325"	1.5	72	<b>F72</b>	<b>188PXBK095</b> (1x) <b>188SFGK095</b> (2x) <b>21BPX072</b>		D1	D2	D5
109, 109 HappyStart, 110*, 111*, 112*, 115*, 115i, 115iH, 115S45, 116, 116 si, 117, 120, 120 si, PS-43, PS-52, PS-460*, PS460-45*, PS-500*, PS-500 C*, PS500C45*, PS-550*, PS550-45*, PS-4600*, PS-4605*, PS4605-45*, PS-5000*, PS-5000 H, PS-5105*, PS-5105 C*, PS-5105 H, PS-5105 CH*, PS5105C4*, PS5105SCKIT45*, PS-6000i, PS-6000iH, PS-6100*, PS6100-45, PS6100-53, PS-6800i, PS-6800iH, *Pitch and motor mount may vary	38	15	3/8"	1.5	56	<b>73DPX056E</b>	<b>158SLHK153</b>		K1	K2	K5
109, 109 HappyStart, 110*, 111*, 112*, 115*, 115i, 115iH, 115S45, 116, 116 si, 117, 120, 120 si, PS-43, PS-52, PS-460*, PS460-45*, PS-500*, PS-500 C*, PS500C45*, PS-550*, PS550-45*, PS-4600*, PS-4605*, PS4605-45*, PS-5000*, PS-5000 H, PS-5105*, PS-5105 C*, PS-5105 H, PS-5105 CH*, PS5105C4*, PS5105SCKIT45*, PS-6000i, PS-6000iH, PS-6100*, PS6100-45, PS6100-53, PS-6800i, PS-6800iH, *Pitch and motor mount may vary	45	18	3/8"	1.5	64	<b>73DPX064E</b>	<b>188SLHK153</b>		K1	K2	K5
109, 109 HappyStart, 110*, 111*, 112*, 115*, 115i, 115iH, 115S45, 116, 116 si, 117, 120, 120 si, PS-43, PS-52, PS-460*, PS460-45*, PS-500*, PS-500 C*, PS500C45*, PS-550*, PS550-45*, PS-4600*, PS-4605*, PS4605-45*, PS-5000*, PS-5000 H, PS-5105*, PS-5105 C*, PS-5105 H, PS-5105 CH*, PS5105C4*, PS5105SCKIT45*, PS-6000i, PS-6000iH, PS-6100*, PS6100-45, PS6100-53, PS-6800i, PS-6800iH, *Pitch and motor mount may vary	50	20	3/8"	1.5	72	<b>L72</b>			K1	K2	K5
PS-630, PS-6400, PS-6400 H, PS-7300, PS-7300 H, PS-7310, PS7310-50, PS-7310 H, PS-7900, PS-7900 H, PS-7910, PS7910-53, PS-7910 H, PS7910-60PM	38	15	3/8"	1.5	56	<b>73DPX056E</b>	<b>158SFHD009</b> (1x) <b>158SFHD009</b> (2x) <b>73DPX056</b>		K1	K2	K5
PS-630, PS-6400, PS-6400 H, PS-7300, PS-7300 H, PS-7310, PS7310-50, PS-7310 H, PS-7900, PS-7900 H, PS-7910, PS7910-53, PS-7910 H, PS7910-60PM	45	18	3/8"	1.5	68	<b>L68</b>	<b>188SFHD009</b> (1x) <b>188SFHD009</b> (2x) <b>73DPX068</b>		K1	K2	K5
PS-630, PS-6400, PS-6400 H, PS-7300, PS-7300 H, PS-7310, PS7310-50, PS-7310 H, PS-7900, PS-7900 H, PS-7910, PS7910-53, PS-7910 H, PS7910-60PM	50	20	3/8"	1.5	72	<b>L72</b>	<b>208SFHD009</b> (1x) <b>208SFHD009</b> (2x) <b>73DPX072</b>		K1	K2	K5



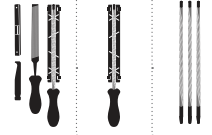
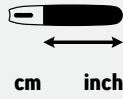
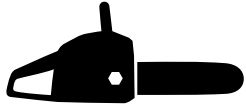

DYNAMAC™											
DY36, DY19E	40	16	3/8" LOW PROFILE	1.3	57	<b>B57</b>	<b>160SDEA041</b>		B1	B2	B5
DY51/46	45	18	.325"	1.5	72	<b>F72</b>	<b>188PXBK095</b>	(1x) <b>188SFGK095</b> (2x) <b>21BPX072</b>	D1	D2	D5
ECHO™											
PPF-225*, PPT-280*, PPT-2620ES*, PPT-2620HES*	30	12	3/8" LOW PROFILE	1.1	44	<b>A44</b>			A1	A2	A5
*Gauge may vary	30	12	3/8" LOW PROFILE	1.1	45	<b>A45</b>	<b>124MLEA041</b>		A1	A2	A5
CS-310ES*, CS-352AC, CS-352ES*, CS-3510AC*, CS-3510ES*, DCS-310, DCS-3500, ECCS-58V, DCS58V, DCS-1600	30	12	3/8" LOW PROFILE	1.1	45	<b>A45</b>	<b>124MLEA041</b>		A1	A2	A5
*Gauge may vary	35	14	3/8" LOW PROFILE	1.1	52	<b>A52</b>	<b>144MLEA041</b>		A1	A2	A5
	40	16	3/8" LOW PROFILE	1.1	56	<b>A56</b>	<b>164MLEA041</b>		A1	A2	A5
PPF-225*, PPF-236ES, PPT-236ES, PPT-265ES, PPT-266, PPT-280*, PPT-300ES, PPT-2620ES*, PPT-2620HES*	25	10	3/8" LOW PROFILE	1.3	39		<b>100SDEA041</b>		B1	B2	B5
*Gauge may vary	30	12	3/8" LOW PROFILE	1.3	44	<b>B44</b>			B1	B2	B5
CS-260T, CS-260TES, CS-270WES, CS-280T, CS-280TES, CS-281WES, CS-2510TES, CS-2511TES, CS-2511WES, DCS-2500T	25	10	3/8" LOW PROFILE	1.3	40	<b>B40</b>	<b>100SDEA041</b>		B1	B2	B5
	30	12	3/8" LOW PROFILE	1.3	45	<b>B45</b>	<b>120SDEA041</b>	(1x) <b>120SDEA041</b> (2x) <b>91P045</b>	B1	B2	B5
	30	12	3/8" LOW PROFILE	1.3	47				B1	B2	B5
CS-285EVL, CS-290EVL, CS-300EVL, CS-302, CS-303, CS-303T, CS-310ES*, CS-315, CS-320T, CS-320TES, CS-320EVL, CS-328, CS-330EVL, CS-340, CS-341, CS-345, CS-350T, CS-350TES, CS-350WES, CS-351WES, CS-352AC, CS-352ES*, CS-353ES, CS-360TES*, CS-360EVL*, CS-360WES, CS-361WES, CS-362TES, CS-362WES*, CS-370ES*, CS-1800, CS-2000, CS-2400, CS-2600, CS-2800, CS-2900, CS-3000, CS-3050, CS-3400, CS-3450, CS-3500, CS-3510AC*, CS-3510ES*, CS-3510L, CS-4400, E155, ECS-150/1850FT, ECS-2000, ECS-3000, ECS-3050	30	12	3/8" LOW PROFILE	1.3	45	<b>B45</b>	<b>120SDEA041</b>	(1x) <b>120SDEA041</b> (2x) <b>91P045</b>	B1	B2	B5
	30	12	3/8" LOW PROFILE	1.3	47				B1	B2	B5
	35	14	3/8" LOW PROFILE	1.3	52	<b>B52</b>	<b>140SDEA041</b>	(1x) <b>140SDEA041</b> (2x) <b>91P052</b>	B1	B2	B5
	35	14	3/8" LOW PROFILE	1.3	53	<b>B53</b>			B1	B2	B5
	40	16	3/8" LOW PROFILE	1.3	56	<b>B56</b>	<b>160SDEA041</b>	(1x) <b>160SDEA041</b> (2x) <b>91P056</b>	B1	B2	B5
	40	16	3/8" LOW PROFILE	1.3	57	<b>B57</b>			B1	B2	B5
*Pitch and/or Gauge may vary by year	40	16	3/8" LOW PROFILE	1.3	58				B1	B2	B5
	33	13	.325"	1.3	56	<b>D56</b>	<b>130MLBK041</b>		D1	D2	D5
CS-390ESX, CS-4200ES, CS-4310SX	38	15	.325"	1.3	64	<b>D64</b>	<b>150MLBK041</b>		D1	D2	D5
	40	16	.325"	1.3	66	<b>D66</b>	<b>160MLBK041</b>		D1	D2	D5
	33	13	.325"	1.3	56	<b>D56</b>	<b>130MLBK095</b>	(1x) <b>130MLBK095</b> (2x) <b>95TXL056</b>	D1	D2	D5
CS-4510ES-NC	38	15	.325"	1.3	64	<b>D64</b>	<b>150MLBK095</b>	(1x) <b>150MLBK095</b> (2x) <b>95TXL064</b>	D1	D2	D5
	45	18	.325"	1.3	72	<b>D72</b>	<b>180MLBK095</b>	(1x) <b>180MLBK095</b> (2x) <b>95TXL072</b>	D1	D2	D5

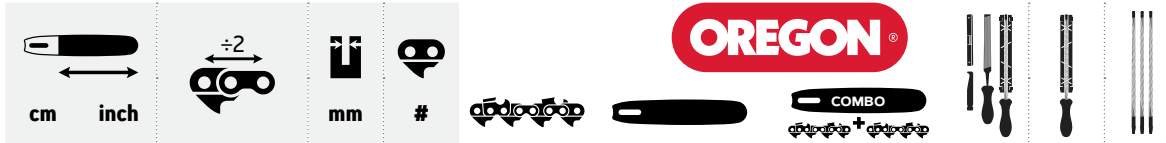
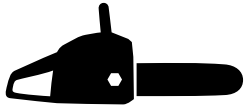

**ECHO™ /.**

CS-360EVL*, CS-370ES*, CS-400EVL, CS-420ES, CS-421ES, CS-440EVL, CS-450**, CS-452ESX, CS-490ES, CS-500ES, CS-501SX, CS-501SXH, CS-510, CS-525, CS-550**, CS-3600, CS-3700, CS-3700ES, CS-3900, CS-4000, CS-4010, CS-4050, CS-4200, CS-4400, CS-4500, , CS-4600, CS-4601, CS-4610, CS-5000, CS-5100 * Pitch and/or gauge may vary by year ** Motor mount may vary by year	33	13	.325"	1.5	56	<b>F56</b>	<b>138PXBK041</b>		D1	D2	D5
	38	15	.325"	1.5	64	<b>F64</b>	<b>158PXBK041</b>		D1	D2	D5
	40	16	.325"	1.5	66	<b>F66</b>	<b>168PXBK041</b>		D1	D2	D5
	45	18	.325"	1.5	72	<b>F72</b>	<b>188VXLGK041</b>		D1	D2	D5
	33	13	.325"	1.5	56	<b>F56</b>	<b>138PXBK095</b>	(1x) <b>138PXBK095</b> (2x) <b>21BPX056</b>	D1	D2	D5
CS-450**, CS-550**, CS-4510ES ** Motor mount may vary by year	38	15	.325"	1.5	64	<b>F64</b>	<b>158PXBK095</b>	(1x) <b>158PXBK095</b> (2x) <b>21BPX064</b>	D1	D2	D5
	40	16	.325"	1.5	66	<b>F66</b>	<b>168PXBK095</b>		D1	D2	D5
	45	18	.325"	1.5	72	<b>F72</b>	<b>188PXBK095</b>	(1x) <b>188SFGK095</b> (2x) <b>21BPX072</b>	D1	D2	D5
CS-590, CS-600, CS-600S, CS-605, CS-610, CS-620SX, CS-621SX, CS-680, CS-680S, CS-7310SX, CS-8002	45	18	3/8"	1.5	68	<b>L68</b>	<b>188SFHD009</b>	(1x) <b>188SFHD009</b> (2x) <b>73DPX068</b>	K1	K2	K5
	50	20	3/8"	1.5	72	<b>L72</b>	<b>208SFHD009</b>	(1x) <b>208SFHD009</b> (2x) <b>73DPX072</b>	K1	K2	K5

**ED JOHNSON™**

ML-KW08-405-1	40	16	3/8" LOW PROFILE	1.3	57	<b>B57</b>	<b>160SDEA041</b>		B1	B2	B5
---------------	----	----	------------------	-----	----	------------	-------------------	--	----	----	----

**EFCO™**

EP 90, EP 100, EP 120, PTX 2700, PTX 2710	25	10	3/8" LOW PROFILE	1.1	39		<b>104MLEA318</b>		A1	A2	A5
EF 15E, MTi 30	30	12	3/8" LOW PROFILE	1.1	45	<b>A45</b>	<b>124MLEA041</b>		A1	A2	A5
PTH 2500	25	10	3/8" LOW PROFILE	1.3	40	<b>B40</b>			B1	B2	B5
MT 2200 Li-ion, MTT 3600	30	12	3/8" LOW PROFILE	1.3	45	<b>B45</b>	<b>120SDEA041</b>	(1x) <b>120SDEA041</b> (2x) <b>91P045</b>	B1	B2	B5
	35	14	3/8" LOW PROFILE	1.3	52	<b>B52</b>	<b>140SDEA041</b>	(1x) <b>140SDEA041</b> (2x) <b>91P052</b>	B1	B2	B5
MTT 2500*, MT 2600* * Pitch may vary	25	10	3/8" LOW PROFILE	1.3	40	<b>B40</b>	<b>100SDEA041</b>		B1	B2	B5
	35	14	3/8" LOW PROFILE	1.3	50	<b>B50</b>	<b>140SDEA041</b>		B1	B2	B5
EF 17E, EF 19E	40	16	3/8" LOW PROFILE	1.3	57	<b>B57</b>	<b>160SDEA041</b>		B1	B2	B5
125, 131, 132, 132 S, 132 SK, 137, 141S, MT 350, MT 350S, MT 371, MTH 400, MTH 402, MT 411*, MT 1800 E, MT 2000 E, MT 3500, MT 3500S, MT 3700, MT 3710*, MTH 4000, MT 4100S, MT 4110* * Pitch may vary	35	14	3/8" LOW PROFILE	1.3	53	<b>B53</b>	<b>140SDEA041</b>		B1	B2	B5
	40	16	3/8" LOW PROFILE	1.3	57	<b>B57</b>	<b>160SDEA041</b>		B1	B2	B5
114E, 115, 116E, 117E, 119, 134, 135, 136, 140, 140S	40	16	3/8" LOW PROFILE	1.3	56	<b>B56</b>			B1	B2	B5
	40	16	3/8" LOW PROFILE	1.3	57	<b>B57</b>	<b>160SDEA129</b>		B1	B2	B5
	33	13	.325"	1.3	56	<b>D56</b>	<b>130MLBK041</b>		D1	D2	D5
141SP, MT 411*, MT 440, MT 451, MT 3710*, MT 4100 SP, MT 4110*, MT 4400, MT 4510 * Pitch may vary	38	15	.325"	1.3	64	<b>D64</b>	<b>150MLBK041</b>		D1	D2	D5
	40	16	.325"	1.3	66	<b>D66</b>	<b>160MLBK041</b>		D1	D2	D5
	45	18	.325"	1.3	72	<b>D72</b>	<b>180MLBK041</b>		D1	D2	D5



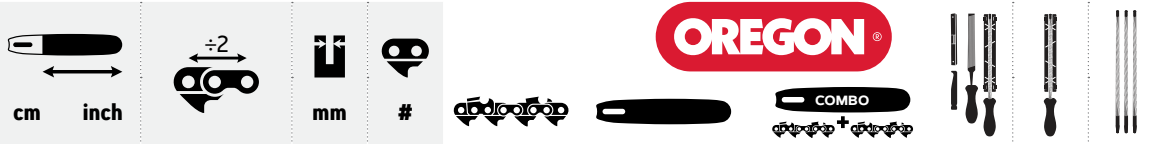
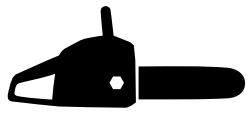

EFCO™ ./. .	cm	inch	mm	#	D	Model	Accessories	D1	D2	D5	
MTH 510*, MTH 560*, MTH 5100*, MTH 5600* *Pitch and/or gauge may vary	33	13	.325"	1.3	56	D56	130MLBK095	(1x) 130MLBK095 (2x) 95TXL056	D1	D2	D5
	38	15	.325"	1.3	64	D64	150MLBK095	(1x) 150MLBK095 (2x) 95TXL064	D1	D2	D5
	40	16	.325"	1.3	66	D66	160MLBK095		D1	D2	D5
	45	18	.325"	1.3	72	D72	180MLBK095	(1x) 180MLBK095 (2x) 95TXL072	D1	D2	D5
142, 146, 147, 151, 152*, 156*, 162*, 165, MTH 510*, MTH 560*, MTH 5100*, MT 5200, MTH 5600*, MT 6300* *Pitch and/or gauge may vary	33	13	.325"	1.5	56	F56	138PXBK095	(1x) 138PXBK095 (2x) 21BPX056	D1	D2	D5
	38	15	.325"	1.5	64	F64	158PXBK095	(1x) 158PXBK095 (2x) 21BPX064	D1	D2	D5
	40	16	.325"	1.5	66	F66	168PXBK095		D1	D2	D5
	45	18	.325"	1.5	72	F72	188PXBK095	(1x) 188SFGK095 (2x) 21BPX072	D1	D2	D5
	50	20	.325"	1.5	78	F78	208PXBK095		D1	D2	D5
152*, 156*, 162*, MTH 510*, MTH 560*, MTH 5100*, MTH 5600*, MT 6300* *Pitch and/or gauge may vary	45	18	3/8"	1.5	68	L68	188SFHK095		K1	K2	K5
	50	20	3/8"	1.5	72	L72	208VXLHK095		K1	K2	K5
165 HDS, MT 6500, MT 6510,	45	18	3/8"	1.5	68	L68	188SFHD009	(1x) 188SFHD009 (2x) 73DPX068	K1	K2	K5
	50	20	3/8"	1.5	72	L72	208SFHD009	(1x) 208SFHD009 (2x) 73DPX072	K1	K2	K5
MT 7200, MT 8200	45	18	3/8"	1.5	68	L68			K1	K2	K5
	50	20	3/8"	1.5	72	L72	208SFHD024		K1	K2	K5

EGO™	cm	inch	mm	#	D	Model	Accessories	A1	A2	A5
PSA1000, PSX2500	25	10	3/8" LOW PROFILE	1.1	40	A40		A1	A2	A5
	30	12	3/8" LOW PROFILE	1.1	45	A45	124MLEA041	A1	A2	A5
CS1400, CS1400E, CS1600, CS1601E, CS1610E, CSX3000	35	14	3/8" LOW PROFILE	1.1	52	A52	144MLEA041	A1	A2	A5
	40	16	3/8" LOW PROFILE	1.1	56	A56	164MLEA041	A1	A2	A5
CS1800E, CS1801E	45	18	3/8" LOW PROFILE	1.3	62	B62	180SDEA041	B1	B2	B5

EINHELL™	cm	inch	mm	#	D	Model	Accessories	B1	B2	B5	
BG-EC 620T, FORTEXXA 18/20 TH, GC-LC 1815T, GC-EC 7520 T, GC-LC 18/20 Li T, GE-EC 720T, GE-HH18/45 Li T	20	8	3/8" LOW PROFILE	1.1	33	A33	084MLEA041	A1	A2	A5	
GE-CL 18 Li, GE-LC 18 Li, GE-LC 18/25 Li	25	10	3/8" LOW PROFILE	1.1	40	A40		A1	A2	A5	
	30	12	3/8" LOW PROFILE	1.1	45	A45	124MLEA041	A1	A2	A5	
FORTEXXA 18/30, GE-LC 36/35 Li, GP-LC 36/35 Li	35	14	3/8" LOW PROFILE	1.1	52	A52	144MLEA041	A1	A2	A5	
	40	16	3/8" LOW PROFILE	1.1	56	A56	164MLEA041	A1	A2	A5	
GC-EC 750 T Kit, GC-LC 750 T Kit, GE-HC 18 Li T, GE-LC 18 Li T	20	8	3/8" LOW PROFILE	1.3	33	B33	080SDEA041	B1	B2	B5	
GC-MM 52 I AS	25	10	3/8" LOW PROFILE	1.3	39	91PX039E	100SDEA041	B1	B2	B5	
EK 1535, EK 1540, KSE 1640, KSE 1435, KSE 2000, PES 30/2, PES 34/2, PES 34/3, PES 35, PES 35/2TS, PES 35/3, PES 35/3TS, PES 40/3, PES 1540, PES 1640, PES 2000, PKS 35/1AV, PKS 40/1AV	30	12	3/8" LOW PROFILE	1.3	45	B45	120SDEA041	(1x) 120SDEA041 (2x) 91P045	B1	B2	B5
	35	14	3/8" LOW PROFILE	1.3	52	B52	140SDEA041	(1x) 140SDEA041 (2x) 91P052	B1	B2	B5
	40	16	3/8" LOW PROFILE	1.3	57	B57	160SDEA041		B1	B2	B5
BKS 38-35, MKS 35/35	35	14	3/8" LOW PROFILE	1.3	49	B49	140SDEA318		B1	B2	B5
BG-PC 1235, BG-PC 3735, GC-EC 1935, GC-PC 1235, GC-PC 1335, GC-PC 1435 ITC, GH-EC 1835, RBK 3735	35	14	3/8" LOW PROFILE	1.3	52	B52	140SDEA041	(1x) 140SDEA041 (2x) 91P052	B1	B2	B5

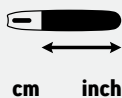

EINHELL™ /./.												
BG-PC 1235, GC-PC 1235 I, GC-PC 1335/11, GH-PC 1535TC	35	14	3/8" LOW PROFILE	1.3	53	<b>B53</b>	<b>140SDEA041</b>			B1	B2	B5
MKS 38/41, MKS 1940, RBK 1440	40	16	3/8" LOW PROFILE	1.3	54		<b>160SDEA318</b>			B1	B2	B5
PES 1640/1, PES 1740, PES 1840/1	40	16	3/8" LOW PROFILE	1.3	55	<b>B55</b>	<b>160SDEA318</b>			B1	B2	B5
GC-PC-2040, GE-EC 2240, GH-EC 2040, GH-EC 2240	40	16	3/8" LOW PROFILE	1.3	56	<b>B56</b>	<b>160SDEA041</b>	(1x) <b>160SDEA041</b> (2x) <b>91P056</b>		B1	B2	B5
BG-EC 1840, BG-EC 2040, BG-PC 4040, EKS 1840, EKS 2040 P, GC-EC 2040, GC-PC 2040 I, KSE 2000, KSE 2040WK, PEK 1840, PKS 1635, PKS 1840, PKS 2040WK, Pro Work PEK 1840, RBC 4640, RBK 4040, REK 2040WK, REK 2048, REK 1840, RG-EC 2240S, SCS 2000	40	16	3/8" LOW PROFILE	1.3	57	<b>B57</b>	<b>160SDEA041</b>			B1	B2	B5
EKS 1845, MKS 38/45, MKS 42/45, RBK 1745	45	18	3/8" LOW PROFILE	1.3	60	<b>91P060E</b>				B1	B2	B5
PKS45/1AV, PKS50/1AV	33	13	.325"	1.5	56	<b>F56</b>	<b>138PXBK095</b>	(1x) <b>138PXBK095</b> (2x) <b>21BPX056</b>		D1	D2	D5
	38	15	.325"	1.5	64	<b>F64</b>	<b>158PXBK095</b>	(1x) <b>158PXBK095</b> (2x) <b>21BPX064</b>		D1	D2	D5
	40	16	.325"	1.5	66	<b>F66</b>	<b>168PXBK095</b>			D1	D2	D5
	45	18	.325"	1.5	72	<b>F72</b>	<b>188PXBK095</b>	(1x) <b>188SFGK095</b> (2x) <b>21BPX072</b>		D1	D2	D5
BG-PC5045, RBK 4645, RBK 5045	45	18	.325"	1.5	72	<b>F72</b>	<b>188PXBK095</b>	(1x) <b>188SFGK095</b> (2x) <b>21BPX072</b>		D1	D2	D5
ELECTROLUX™												
EL1750-14, ESV1914	35	14	3/8" LOW PROFILE	1.3	50	<b>B50</b>	<b>140SDEA318</b>			B1	B2	B5
2115	35	14	3/8" LOW PROFILE	1.3	52	<b>B52</b>	<b>140SDEA041</b>	(1x) <b>140SDEA041</b> (2x) <b>91P052</b>		B1	B2	B5
ERBAUER™												
HCS128T	30	12	.325" LOW PROFILE	1.1	51	<b>N51</b>	<b>124TXLNA041</b>			B1	B2	B5
ECSP41	40	16	.325" LOW PROFILE	1.1	64	<b>N64</b>	<b>164TXLNA041</b>			B1	B2	B5
ECSG18-Li	30	12	3/8" LOW PROFILE	1.1	45	<b>A45</b>	<b>124MLEA041</b>			A1	A2	A5
ECSG3640-Li	40	16	3/8" LOW PROFILE	1.1	56	<b>A56</b>	<b>164MLEA041</b>			A1	A2	A5
EMT36-Li	25	10	3/8" LOW PROFILE	1.3	40	<b>B40</b>	<b>100SDEA041</b>			B1	B2	B5
E6MTP46	25	10	3/8" LOW PROFILE	1.3	40	<b>B40</b>				B1	B2	B5
HCS145	45	18	.325"	1.3	72	<b>D72</b>	<b>180MLBK095</b>	(1x) <b>180MLBK095</b> (2x) <b>95TXL072</b>		D1	D2	D5
ECSP51	50	20	.325"	1.3	78	<b>D78</b>	<b>200TXLBK095</b>			D1	D2	D5
ERGO-TOOLS™												
E-EAS620	20	8	3/8" LOW PROFILE	1.1	33	<b>A33</b>				A1	A2	A5
FEAS6020T Pole Saw	20	8	3/8" LOW PROFILE	1.3	33	<b>B33</b>				B1	B2	B5
E-KS2035	35	14	3/8" LOW PROFILE	1.3	52	<b>B52</b>	<b>140SDEA041</b>	(1x) <b>140SDEA041</b> (2x) <b>91P052</b>		B1	B2	B5
FEKS2040	40	16	3/8" LOW PROFILE	1.3	57	<b>B57</b>				B1	B2	B5
FARMER™												
MKS 350	35	14	3/8" LOW PROFILE	1.3	49	<b>B49</b>	<b>140SDEA318</b>			B1	B2	B5
MKS360, MKS 360W	35	14	3/8" LOW PROFILE	1.3	53	<b>B53</b>	<b>140SDEA041</b>			B1	B2	B5
FERREX™												
FS-AKS 4030	30	12	3/8" LOW PROFILE	1.3	45	<b>B45</b>	<b>120SDEA041</b>	(1x) <b>120SDEA041</b> (2x) <b>91P045</b>		B1	B2	B5



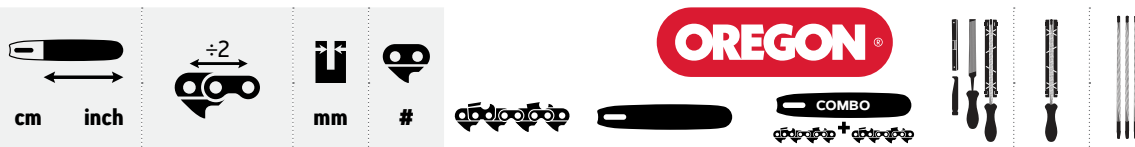

FEVILL™	cm	inch		mm	#						
SCS 723	40	16	3/8" LOW PROFILE	1.1	56	A56			A1	A2	A5
<b>FIVEA™</b>											
2200W	35	14	3/8" LOW PROFILE	1.3	53	B53	140SDEA041		B1	B2	B5
GCS 3800	40	16	3/8" LOW PROFILE	1.3	57	B57	160SDEA041		B1	B2	B5
<b>FLEURELLE™</b>											
FEKS 2040, KSE2040	40	16	3/8" LOW PROFILE	1.3	57	B57	160SDEA041		B1	B2	B5
<b>FLO™</b>											
FLO 2000 79820	40	16	3/8" LOW PROFILE	1.3	57	B57	160SDEA041		B1	B2	B5
FLO 79832, FLO 7982	45	18	.325"	1.5	72	F72	188PXBK095 (1x) 188SFGK095 (2x) 21BPX072		D1	D2	D5
<b>FLORABEST™</b>											
Pole Saw 550Watt, FHE550A1	25	10	3/8" LOW PROFILE	1.3	40	B40			B1	B2	B5
FKS2000A1, FKS2000B1, FKS2000/6, FKS2000/7, FKS22000A1, FKS2200 B1, FKS2200/1, FKS200/08, FKS2200/8, FKS2200/9, FKS2200/10	40	16	3/8" LOW PROFILE	1.3	57	B57	160SDEA041		B1	B2	B5
<b>FLORASELF™</b>											
538, PE 1401	35	14	3/8" LOW PROFILE	1.3	44	B44	140SDEA318		B1	B2	B5
	40	16	3/8" LOW PROFILE	1.3	49	B49	160SDEA318		B1	B2	B5
	30	12	3/8" LOW PROFILE	1.3	45	B45			B1	B2	B5
CS35, P38, 330 Elektro 1500 Watt	35	14	3/8" LOW PROFILE	1.3	50	B50	140SDEA318		B1	B2	B5
	40	16	3/8" LOW PROFILE	1.3	55	B55	160SDEA318		B1	B2	B5
330 Elektro, 335 Elektro, 340 Elektro	30	12	3/8" LOW PROFILE	1.3	45	B45			B1	B2	B5
	35	14	3/8" LOW PROFILE	1.3	50	B50			B1	B2	B5
40	16	3/8" LOW PROFILE	1.3	55	B55			B1	B2	B5	
<b>FOR_Q™</b>											
FQ-AHE 4020 Basic	20	8	3/8" LOW PROFILE	1.3	33	B33			B1	B2	B5
FQ-AKS 4030 Basic	30	12	3/8" LOW PROFILE	1.3	45	B45	120SDEA041 (1x) 120SDEA041 (2x) 91P045		B1	B2	B5
<b>GARDEN™</b>											
GD33, GD36, Euro35N, P360	35	14	3/8" LOW PROFILE	1.3	50	B50			B1	B2	B5
GD33, GD39, P390	40	16	3/8" LOW PROFILE	1.3	56	B56			B1	B2	B5
GD45, P450	45	18	.325"	1.5	72	F72			D1	D2	D5
GD50, P500	50	20	.325"	1.5	78	F78			D1	D2	D5
<b>GARDEN MASTER™</b>											
GM06023	40	16	3/8" LOW PROFILE	1.3	57	B57	160SDEA041		B1	B2	B5
<b>GARDENA™</b>											
TCS 720/20, TCS Li-18/20, CST 2018 Li	20	8	3/8" LOW PROFILE	1.1	33	A33			A1	A2	A5
CST2018-LI	20	8	3/8" LOW PROFILE	1.1	34	90PX034E			A1	A2	A5
CST3018	30	12	3/8" LOW PROFILE	1.3	45	B45	120SDEA041 (1x) 120SDEA041 (2x) 91P045		B1	B2	B5
CST3519CX, CST 3518-X, CST 3519-X	35	14	3/8" LOW PROFILE	1.3	52	B52	140SDEA041 (1x) 140SDEA041 (2x) 91P052		B1	B2	B5
CSI 4020, CSI 4020-X	40	16	3/8" LOW PROFILE	1.3	57	B57	160SDEA041		B1	B2	B5

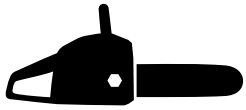

GARDOL™											
GETS-E-710 Kit	20	8	3/8" LOW PROFILE	1.1	33	A33			A1	A2	A5
Pole Saw GASI 24-20, GETS-E-710 Kit, GHH-E20 Li, GATS-E 20 LI	20	8	3/8" LOW PROFILE	1.3	33	B33	080SDEA041		B1	B2	B5
GPS 182B	30	12	3/8" LOW PROFILE	1.3	44	B44	120SDEA318		B1	B2	B5
GMSE 1335, GMSE 1535	35	14	3/8" LOW PROFILE	1.3	53	B53	140SDEA041		B1	B2	B5
GEK-E 2240	40	16	3/8" LOW PROFILE	1.3	56	B56	160SDEA041 (1x) 160SDEA041 (2x) 91P056		B1	B2	B5
GEK125-40 PRO, GMS-E-40EV	40	16	3/8" LOW PROFILE	1.3	57	B57	160SDEA041		B1	B2	B5
GMS-E_45EV, GMSE 2245	45	18	.325"	1.5	72	F72	188PXBK095		D1	D2	D5
GO/ON™											
PC1800 Watt, EKS1835/2, TESG1835	35	14	3/8" LOW PROFILE	1.3	53	B53	140SDEA041		B1	B2	B5
EK 1800	40	16	3/8" LOW PROFILE	1.3	57	B57			B1	B2	B5
GREENLINE™											
G-36	35	14	3/8" LOW PROFILE	1.3	52	B52			B1	B2	B5
GREENWORKS™											
Pole Saw 20107	20	8	3/8" LOW PROFILE	1.1	33	A33	084MLEA041		A1	A2	A5
GD40CS15 (CSF403), GD48CS36 (CSE402)	35	14	3/8" LOW PROFILE	1.1	52	A52	144MLEA041		A1	A2	A5
GD40CS18, GD40CS40* *Gauge may vary and be 1.3mm	40	16	3/8" LOW PROFILE	1.1	56	A56	164MLEA041		A1	A2	A5
G24PS20, G40PS20, G40PSF (20157), G48PS (PSE302), GPS7220	20	8	3/8" LOW PROFILE	1.3	33	B33	080SDEA041		B1	B2	B5
G24CS25	25	10	3/8" LOW PROFILE	1.3	40	B40	100SDEA041		B1	B2	B5
	25	10	3/8" LOW PROFILE	1.3	40	B40	100SDEA041		B1	B2	B5
G40CS30, GCS1840, GCS2046, GD24CS30, GD40CS40*, GD60CS40, GD80CS50, GPS7220, 1800W 20027	30	12	3/8" LOW PROFILE	1.3	45	B45	120SDEA041 (1x) 120SDEA041 (2x) 91P045		B1	B2	B5
	40	16	3/8" LOW PROFILE	1.3	56	B56	160SDEA041 (1x) 160SDEA041 (2x) 91P056		B1	B2	B5
*Gauge may vary and be 1.1mm	45	18	3/8" LOW PROFILE	1.3	62	B62	180SDEA041		B1	B2	B5
GRIZZLY™											
EKS 1800-40, EKS 1800-40-i, EKS1800-40I, Parkside EKS 1650	40	16	3/8" LOW PROFILE	1.1	55				A1	A2	A5
EKS 610T, KSHS 710-500	20	8	3/8" LOW PROFILE	1.3	33	B33			B1	B2	B5
Pole Saw 550 Watt, Art-Nr: 75010036, AKS 2040	25	10	3/8" LOW PROFILE	1.3	40	B40			B1	B2	B5
	30	12	3/8" LOW PROFILE	1.3	44	B44			B1	B2	B5
BKS 35-32cc	35	14	3/8" LOW PROFILE	1.3	50	B50			B1	B2	B5
BKS 35-14, EKS 1600, EKS 1800, MKS350	35	14	3/8" LOW PROFILE	1.3	49	B49	140SDEA318		B1	B2	B5
	35	14	3/8" LOW PROFILE	1.3	50	B50			B1	B2	B5
PKS 360, PKS 390	40	16	3/8" LOW PROFILE	1.3	56	B56			B1	B2	B5
BKS 35N, BKS 35-38cc, Farmer MKS360	35	14	3/8" LOW PROFILE	1.3	50	B50			B1	B2	B5
PKS 35	35	14	3/8" LOW PROFILE	1.3	52	B52			B1	B2	B5
BKS 350, BKS 351, EKS 1835-2, EKS 1600/7, EKS 1600/8, EKS 1600/9, EKS1835/2, EKS1835QT	35	14	3/8" LOW PROFILE	1.3	53	B53	140SDEA041		B1	B2	B5
	35	14	3/8" LOW PROFILE	1.3	53	B53			B1	B2	B5
BKS 400	40	16	3/8" LOW PROFILE	1.3	57	B57			B1	B2	B5
BKS 38-16	40	16	3/8" LOW PROFILE	1.3	54		160SDEA318		B1	B2	B5
EKS 1650	40	16	3/8" LOW PROFILE	1.3	55	B55			B1	B2	B5



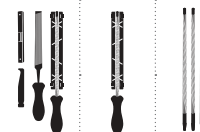
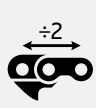
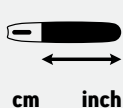

### GRIZZLY™ ./.

EKS 2000, EKS 2000 QT, EKS 2500/5, EKS 2500, EKS 2500QT, EKS 2500/5, EKS 2500/5QT, PKS 2000/4, PKS 40, PKS 40/3, KS400I, KSE400TL, KSE 400TL, PKS2000/4	40	16	3/8" LOW PROFILE	1.3	55	<b>B55</b>	<b>160SDEA318</b>		B1	B2	B5
BKS 35-38cc, BKS 35-40cc, EKS Elektra 170, EKS 1700, EKS 1700-40, EKS 1800, EKS 1800-40, P390	40	16	3/8" LOW PROFILE	1.3	56	<b>B56</b>			B1	B2	B5
PKS 40/5	40	16	3/8" LOW PROFILE	1.3	57	<b>B57</b>			B1	B2	B5
Comet CKS2000, EKS2440QT, Florabest FKS2200/10, Parkside PKS40/5, PKS40/5, EKS 1835QT, EKS 1800-40, EKS 1850, EKS 1850/1, EKS 200/40, EKS 2000/6, EKS 2000/6QT, EKS 2000/8, EKS 2000/8QT, EKS 2200QT, BKS400	40	16	3/8" LOW PROFILE	1.3	57	<b>B57</b>	<b>160SDEA041</b>		B1	B2	B5
BKS 35-40cc	45	18	3/8" LOW PROFILE	1.3	60				B1	B2	B5
BKS 450-8	40	16	.325"	1.5	66	<b>F66</b>			D1	D2	D5

### GÜDE™

GAK 600	20	8	3/8" LOW PROFILE	1.1	33	<b>A33</b>			A1	A2	A5
E-KS 350E	35	14	3/8" LOW PROFILE	1.3	52	<b>B52</b>			B1	B2	B5
KS350E, KS350B	35	14	3/8" LOW PROFILE	1.3	53	<b>B53</b>			B1	B2	B5
K450B, E-KS 400, E-KS 401E	40	16	3/8" LOW PROFILE	1.3	57	<b>B57</b>	<b>160SDEA041</b>		B1	B2	B5
KS450-53	45	18	3/8" LOW PROFILE	1.3	62	<b>B62</b>	<b>180SDEA095</b>		B1	B2	B5
K400B	40	16	.325"	1.5	66	<b>F66</b>			D1	D2	D5

### HANDY POWER™

HP35TT, HANDY.P.35CC EPA2	35	14	3/8" LOW PROFILE	1.3	49	<b>B49</b>	<b>140SDEA318</b>		B1	B2	B5
HP1400TE 1400W	35	14	3/8" LOW PROFILE	1.3	52	<b>B52</b>	<b>140SDEA041</b>	(1x) <b>140SDEA041</b> (2x) <b>91P052</b>	B1	B2	B5

### HANSEATIC™

EKS 1640	40	16	3/8" LOW PROFILE	1.3	57	<b>B57</b>	<b>160SDEA041</b>		B1	B2	B5
----------	----	----	------------------	-----	----	------------	-------------------	--	----	----	----

### HERKULES™

HHEK 18-35/1	35	14	3/8" LOW PROFILE	1.3	52	<b>B52</b>	<b>140SDEA041</b>	(1x) <b>140SDEA041</b> (2x) <b>91P052</b>	B1	B2	B5
36/35, HHEK 22-40, PKS 1840, 18/41, 39/41, P 352	35	14	3/8" LOW PROFILE	1.3	52	<b>B52</b>	<b>140SDEA041</b>	(1x) <b>140SDEA041</b> (2x) <b>91P052</b>	B1	B2	B5
	40	16	3/8" LOW PROFILE	1.3	57	<b>B57</b>	<b>160SDEA041</b>		B1	B2	B5
41/ 41AB 2003	40	16	3/8" LOW PROFILE	1.3	56	<b>B56</b>			B1	B2	B5
MKS 42-45	45	18	3/8" LOW PROFILE	1.3	60				B1	B2	B5
MKS 4048, P 372	40	16	.325"	1.3	66	<b>D66</b>			D1	D2	D5
41/ 41	40	16	.325"	1.5	66	<b>F66</b>			D1	D2	D5
49/ 46	45	18	.325"	1.5	72	<b>F72</b>	<b>188PXBK095</b>	(1x) <b>188SFGK095</b> (2x) <b>21BPX072</b>	D1	D2	D5

### HITACHI™

CS25EPBS	25	10	3/8" LOW PROFILE	1.1	40	<b>A40</b>			A1	A2	A5
CS25ECS	25	10	3/8" LOW PROFILE	1.3	40	<b>B40</b>			B1	B2	B5
	30	12	3/8" LOW PROFILE	1.3	45	<b>B45</b>	<b>120SDEA041</b>	(1x) <b>120SDEA041</b> (2x) <b>91P045</b>	B1	B2	B5
CS280A, CS280B, CS350A, CS350B	35	14	3/8" LOW PROFILE	1.3	52	<b>B52</b>	<b>140SDEA041</b>	(1x) <b>140SDEA041</b> (2x) <b>91P052</b>	B1	B2	B5
	40	16	3/8" LOW PROFILE	1.3	57	<b>B57</b>	<b>160SDEA041</b>		B1	B2	B5
CS30ECS, CS30EGS, CS30EHS, CS30EJ, CS33EB, CS33ET	30	12	3/8" LOW PROFILE	1.3	45	<b>B45</b>			B1	B2	B5

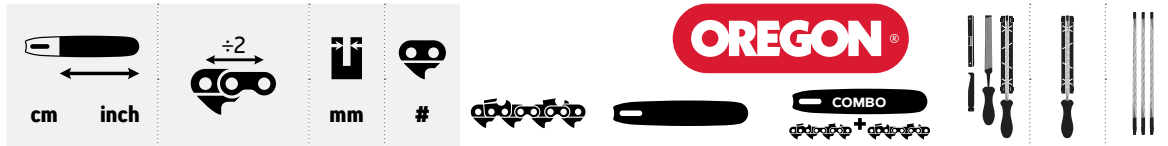

	cm	inch		mm	#						
<b>HITACHI™ /.</b>											
CS35EGS, CS35EHS, CS35EJ	35	14	3/8" LOW PROFILE	1.3	52	<b>B52</b>			B1	B2	B5
	33	13	.325"	1.3	56	<b>D56</b>	<b>130MLBK041</b>		D1	D2	D5
CS33EL, CS33SP, CS38EK, CS38EL, CS40, CS40EAP/38, CS40EK, CS40EL, CS45EK, CS45EL, CS51EA, CS51EAP	38	15	.325"	1.3	64	<b>D64</b>	<b>150MLBK041</b>		D1	D2	D5
	40	16	.325"	1.3	66	<b>D66</b>	<b>160MLBK041</b>		D1	D2	D5
	45	18	.325"	1.3	72	<b>D72</b>	<b>180MLBK041</b>		D1	D2	D5
CS40EM, CS40SM	40	16	.325"	1.5	66	<b>F66</b>			D1	D2	D5
CS45EM	45	18	.325"	1.5	72	<b>F72</b>			D1	D2	D5
<b>HM-MUELLER™</b>											
EKS1800CE	40	16	3/8" LOW PROFILE	1.3	57	<b>B57</b>			B1	B2	B5
<b>HOPEM™</b>											
	30	12	3/8" LOW PROFILE	1.3	45	<b>B45</b>	<b>120SDEA041</b>	(1x) <b>120SDEA041</b> (2x) <b>91P045</b>	B1	B2	B5
1302, 140Z, 142Z	35	14	3/8" LOW PROFILE	1.3	52	<b>B52</b>	<b>140SDEA041</b>	(1x) <b>140SDEA041</b> (2x) <b>91P052</b>	B1	B2	B5
	40	16	3/8" LOW PROFILE	1.3	57	<b>B57</b>	<b>160SDEA041</b>		B1	B2	B5
	33	13	.325"	1.5	56	<b>F56</b>	<b>138PXBK095</b>	(1x) <b>138PXBK095</b> (2x) <b>21BPX056</b>	D1	D2	D5
K1, K2, K3, K2 Super	38	15	.325"	1.5	64	<b>F64</b>	<b>158PXBK095</b>	(1x) <b>158PXBK095</b> (2x) <b>21BPX064</b>	D1	D2	D5
	40	16	.325"	1.5	66	<b>F66</b>			D1	D2	D5
	45	18	.325"	1.5	72	<b>F72</b>	<b>188PXBK095</b>	(1x) <b>188SFGK095</b> (2x) <b>21BPX072</b>	D1	D2	D5
<b>HORNBAACH™</b>											
PWR1800CSC, PP1800TE	35	14	3/8" LOW PROFILE	1.3	52	<b>B52</b>	<b>140SDEA041</b>	(1x) <b>140SDEA041</b> (2x) <b>91P052</b>	B1	B2	B5
	40	16	3/8" LOW PROFILE	1.3	57	<b>B57</b>	<b>160SDEA041</b>		B1	B2	B5
<b>HURRICANE™</b>											
Pole Saw HESI 750-1	20	8	3/8" LOW PROFILE	1.1	33	<b>A33</b>			A1	A2	A5
HAKS-I-4035	35	14	3/8" LOW PROFILE	1.1	52	<b>A52</b>			A1	A2	A5
GPS 70B	30	12	3/8" LOW PROFILE	1.3	44	<b>B44</b>	<b>120SDEA318</b>		B1	B2	B5
MKS 3, MKS 38/35	35	14	3/8" LOW PROFILE	1.3	49	<b>B49</b>	<b>140SDEA318</b>		B1	B2	B5
36/35, HEK 18-35, HEKE18-35/1, HEKE 22-40, GEK-2240	35	14	3/8" LOW PROFILE	1.3	52	<b>B52</b>	<b>140SDEA041</b>	(1x) <b>140SDEA041</b> (2x) <b>91P052</b>	B1	B2	B5
MS1235/1, MS1235/2	35	14	3/8" LOW PROFILE	1.3	53	<b>B53</b>	<b>140SDEA041</b>		B1	B2	B5
MS1235/2, HMS-E35V	35	14	3/8" LOW PROFILE	1.3	53	<b>B53</b>	<b>140SDEA041</b>		B1	B2	B5
PS40, PS400, MKS 38/41	40	16	3/8" LOW PROFILE	1.3	54		<b>160SDEA318</b>		B1	B2	B5
ES2040S	40	16	3/8" LOW PROFILE	1.3	55	<b>B55</b>	<b>160SDEA318</b>		B1	B2	B5
MKS 21/40	40	16	3/8" LOW PROFILE	1.3	55	<b>B55</b>			B1	B2	B5
HEKA20-40, HEKA24-40, HHEK24-40, PS2000-40E	40	16	3/8" LOW PROFILE	1.3	57	<b>B57</b>	<b>160SDEA041</b>		B1	B2	B5
MKS 42/45	45	18	3/8" LOW PROFILE	1.3	60		<b>180SDEA318</b>		B1	B2	B5
MS2245	45	18	.325"	1.5	72	<b>F72</b>			D1	D2	D5
<b>HUSQVARNA™</b>											
330i*, 535i XP**, T535i XP**, 540i XP, T540i XP * Pitch and gauge may vary ** from 2020	30	12	.325" LOW PROFILE	1.1	51	<b>N51</b>	<b>124TXLNA095</b>		B1	B2	B5
	40	16	.325" LOW PROFILE	1.1	64	<b>N64</b>	<b>164TXLNA095</b>		B1	B2	B5
330i*, 436Li, 535i XP**, T535i XP**, 536 Li XP, T536Li XP, 120i, 136i * Pitch and gauge may vary ** Until 2019. Pitch & gauge may vary.	25	10	3/8" LOW PROFILE	1.1	40	<b>A40</b>	<b>104MLEA095</b>		A1	A2	A5
	30	12	3/8" LOW PROFILE	1.1	45	<b>A45</b>	<b>124MLEA095</b>		A1	A2	A5
	35	14	3/8" LOW PROFILE	1.1	52	<b>A52</b>	<b>144MLEA095</b>		A1	A2	A5
323P4*, 325P5X*, 327P4*, 327P5X*, 136Li * Gauge may vary depending on year	30	12	3/8" LOW PROFILE	1.1	45	<b>A45</b>	<b>124MLEA095</b>		A1	A2	A5



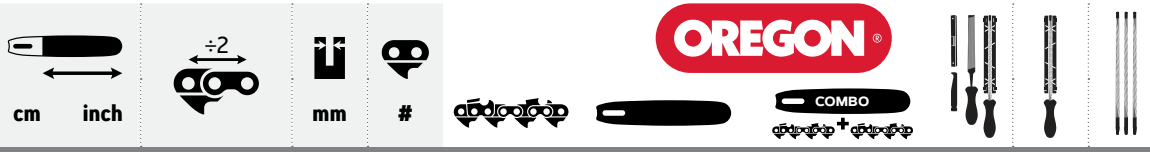
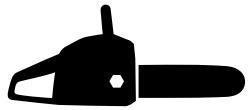

**HUSQVARNA™ /.**

323P4*, 325P5X*, 327P4*, 327P5X* * Gauge may vary depending on year	25	10	3/8" LOW PROFILE	1.3	40	<b>B40</b>		B1	B2	B5
	30	12	3/8" LOW PROFILE	1.3	45	<b>B45</b>	<b>120SDEA095</b>	B1	B2	B5
325P4X, T425	20	8	3/8" LOW PROFILE	1.3	32			B1	B2	B5
	25	10	3/8" LOW PROFILE	1.3	40	<b>B40</b>	<b>100SDEA041</b>	B1	B2	B5
120, 120 II, 120 MARK II, 130, 135, 135e, 135 II, 135 MARK II, 140, 236**, 236e*, 240, 240e*, 315, 315E, 315 EL, 317(1700W), 317 EL (1700W), 321(2000W), 321 EL (2000W), 333, 334, 334T, 335XPT, 338XPT, 340i, 418 EL, 420 EL, T435, T525, 525P4S, 525P5S, T540 XP, T540 XP II, 1400 EL, 1600 EL * Until year 2009 (A095) ** Chain pitch may vary by year	25	10	3/8" LOW PROFILE	1.3	40	<b>B40</b>		B1	B2	B5
	30	12	3/8" LOW PROFILE	1.3	45	<b>B45</b>	<b>120SDEA095</b>	B1	B2	B5
	35	14	3/8" LOW PROFILE	1.3	52	<b>B52</b>	<b>140SDEA095</b>	B1	B2	B5
	40	16	3/8" LOW PROFILE	1.3	56	<b>B56</b>	<b>160SDEA095</b>	B1	B2	B5
	45	18	3/8" LOW PROFILE	1.3	60		<b>180SDEA095</b>	B1	B2	B5
E16, 136**, 137**, 141**, 142**, 235**, 236e*, 240**, 240e*, 243, 250PS, E316, 439 * From year 2010 (A041) ** Chain pitch may vary by year	30	12	3/8" LOW PROFILE	1.3	45	<b>B45</b>	<b>120SDEA041</b> (1x) <b>120SDEA041</b> (2x) <b>91P045</b>	B1	B2	B5
	35	14	3/8" LOW PROFILE	1.3	52	<b>B52</b>	<b>140SDEA041</b> (1x) <b>140SDEA041</b> (2x) <b>91P052</b>	B1	B2	B5
	40	16	3/8" LOW PROFILE	1.3	56	<b>B56</b>	<b>160SDEA041</b> (1x) <b>160SDEA041</b> (2x) <b>91P056</b>	B1	B2	B5
	45	18	3/8" LOW PROFILE	1.3	62	<b>B62</b>	<b>180SDEA041</b>	B1	B2	B5
33, 36, 40, 41, 42, 44, 45, 49, 50, 51, 55, 57, 133, 134, 136**, 137 e-series**, 141**, 142 e-series**, 234, 235**, 236**, 238, 240**, 242, 242 XP, 246, 254 XP, 257, 261, 262, 336, 339XP, 340, 340 e-series, 345, 345 e-series, 346, 346XP/XPG, 350, 351, 353, 357**, 357XP/XPG**, 359**, 360, 362 XP**, 362XPG**, 435, 435e, 435 II, 435e II, 435 e-series, 440, 440e, 440 II, 440e II, 440 e-series, 444, 445, 445e, 445 II, 445 e-series, 450, 450e, 450 e-series, 450 II, 450e II, 450 RANCHER, 455 RANCHER, 455e RANCHER, 455 RANCHER II, 455e RANCHER II, 455 e-series RANCHER, 460, 460 RANCHER, 535FBX (clearing saw), 543XP/XPG, 545, 545 MARK II, 550XP/XPG, 550 XP MARK II, 550 XP TrioBrake, 555, 560 XP, EL16, E1400, 1400E, 1500E, E1600, 1600E ** Chain pitch may vary by year	33	13	.325"	1.3	56	<b>D56</b>	<b>130MLBK095</b> (1x) <b>130MLBK095</b> (2x) <b>95TXL056</b>	D1	D2	D5
	38	15	.325"	1.3	64	<b>D64</b>	<b>150MLBK095</b> (1x) <b>150MLBK095</b> (2x) <b>95TXL064</b>	D1	D2	D5
	40	16	.325"	1.3	66	<b>D66</b>	<b>160MLBK095</b>	D1	D2	D5
	45	18	.325"	1.3	72	<b>D72</b>	<b>180MLBK095</b> (1x) <b>180MLBK095</b> (2x) <b>95TXL072</b>	D1	D2	D5
	50	20	.325"	1.3	78	<b>D78</b>	<b>200TXLBK095</b>	D1	D2	D5
	33, 36, 40P, 41, 42, 44, 49, 50, 55**, 57, 133, 134, 136**, 137**, 140**, 141**, 142**, 142 e-series, 154, 234, 235, 238, 240**, 242, 242XP/XPG, 246, 246XP/XPG, 254**, 254XP/XPG**, 257**, 261**, 262**, 262XP/XPG**, 339XP, 340, 340e series, 353, 359, 360, 362 XP**, 362XPG**, 365, 435, 435e, 435 II, 435e II, 440e, 444, 445, 445e, 450, 450e, 450 II, 450e II, 455, 455 RANCHER, 455 RANCHER II, 455e RANCHER, 455e RANCHER II, 460, 460 RANCHER, 535FBX, 543XP/XPG, 545, 545 II, 545 MARK II, 550XP/XPG, 550 XP II, 550 XP Triobrake, 550 XP MARK II, 555, 560, 560XP/XPG, 562XP/XPG, 576XP/XPG, EL16, EL1200, EL1400, EL1500, EL1600 ** Chain pitch may vary by year Note: many saws fitted in .325 / 1.5mm (21) can be converted to SpeedCut narrow kerf .325 / 1.3mm (95) cutting system. In such a case, both the bar and chain have to be changed	33	13	.325"	1.5	56	<b>F56</b>	<b>138PXBK095</b> (1x) <b>138PXBK095</b> (2x) <b>21BPX056</b>	D1	D2
38		15	.325"	1.5	64	<b>F64</b>	<b>158PXBK095</b> (1x) <b>158PXBK095</b> (2x) <b>21BPX064</b>	D1	D2	D5
40		16	.325"	1.5	66	<b>F66</b>	<b>168PXBK095</b>	D1	D2	D5
45		18	.325"	1.5	72	<b>F72</b>	<b>188PXBK095</b> (1x) <b>188SFGK095</b> (2x) <b>21BPX072</b>	D1	D2	D5
50		20	.325"	1.5	78		<b>208PXBK095</b>	D1	D2	D5

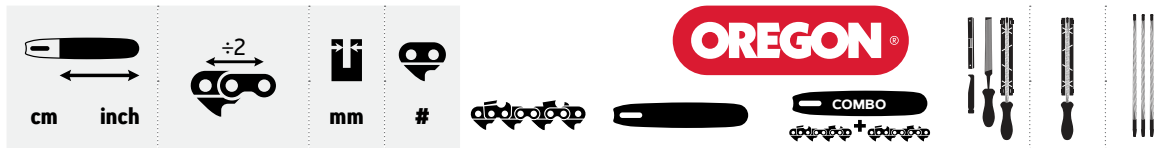

HUSQVARNA™ /..											
	38	15	3/8"	1.5	56				K1	K2	K5
55**, 55 RANCHER, 154, 254**, 254 XP/ XPG**, 257**, 261**, 262**, 262 XP/XPG**, 357, 357 XP/XPG, 359, 362 XP/XPG**, 455, 455 RANCHER, 455e Rancher, 455e RANCHER II, 455 RANCHER II, 460, 460 RANCHER, 465 RANCHER, 545, 550, 550 XP, 555, 560 XP/ XPG	40	16	3/8"	1.5	60				K1	K2	K5
	45	18	3/8"	1.5	64				K1	K2	K5
** Chain pitch may vary by year	45	18	3/8"	1.5	68	<b>L68</b>	<b>188SFHK095</b>		K1	K2	K5
	45	18	3/8"	1.5	68	<b>L68</b>			K1	K2	K5
	50	20	3/8"	1.5	72	<b>L72</b>			K1	K2	K5
	60	24	3/8"	1.5	84				K1	K2	K5
61, 65, 66, 70, 77, 160, 162, 181, 185, 254, 254XP/XPG, 260, 266, 266XP, 268, 268XP, 272, 272XP/XPG, 281, 281XP, 285, 288, 288XP, 298, 298XP, 362XP**, 362 XPG**, 365, 365 XP, 371, 371XP/XPG, 372XP/XPG, 380, 385XP, 390XP, 390XPG, 394, 394XP/XPG, 395, 395XP/XPG, 455, 480, 545, 555, 560XP/XPG, 562XP/XPG, 565, 570 XP, 572 XP, 575 XP, 576XP/XPG, 585, 592 XP, 1100, 2100, 2101, 2100XP, 2101XP, 3120, 3120XP	38	15	3/8"	1.5	56	<b>73DPX056E</b>	<b>158SFHD009</b>	(1x) <b>158SFHD009</b> (2x) <b>73DPX056</b>	K1	K2	K5
** Chain pitch may vary by year	40	16	3/8"	1.5	60		<b>168SFHD009</b>		K1	K2	K5
	45	18	3/8"	1.5	68	<b>L68</b>	<b>188SFHD009</b>	(1x) <b>188SFHD009</b> (2x) <b>73DPX068</b>	K1	K2	K5
	50	20	3/8"	1.5	72	<b>L72</b>	<b>208SFHD009</b>	(1x) <b>208SFHD009</b> (2x) <b>73DPX072</b>	K1	K2	K5
HYUNDAI™											
CS350158Li	35	14	3/8" LOW PROFILE	1.3	52	<b>B52</b>	<b>140SDEA041</b>	(1x) <b>140SDEA041</b> (2x) <b>91P052</b>	B1	B2	B5
IKRA™											
Pole Saw BAS3018, BAS3020	20	8	3/8" LOW PROFILE	1.1	33	<b>A33</b>			A1	A2	A5
IEAS 750	20	8	3/8" LOW PROFILE	1.3	33	<b>B33</b>			B1	B2	B5
	30	12	3/8" LOW PROFILE	1.3	45	<b>B45</b>	<b>120SDEA041</b>	(1x) <b>120SDEA041</b> (2x) <b>91P045</b>	B1	B2	B5
KS1200-B/30, 35, KS1400-B/40	35	14	3/8" LOW PROFILE	1.3	52	<b>B52</b>	<b>140SDEA041</b>	(1x) <b>140SDEA041</b> (2x) <b>91P052</b>	B1	B2	B5
	40	16	3/8" LOW PROFILE	1.3	56	<b>B56</b>	<b>160SDEA041</b>	(1x) <b>160SDEA041</b> (2x) <b>91P056</b>	B1	B2	B5
Shark 1300, KS1400-TS/30, 35, 40; KS1500-T/35, 40; KS1500-TS/35, 40; KS1600-TS/40, 45; KS1800-40CK, KS1800TS-45, EKS-30, 35, 40; MKS 35, 40, IECS1835, IECS2240	30	12	3/8" LOW PROFILE	1.3	45	<b>B45</b>	<b>120SDEA041</b>	(1x) <b>120SDEA041</b> (2x) <b>91P045</b>	B1	B2	B5
	35	14	3/8" LOW PROFILE	1.3	52	<b>B52</b>	<b>140SDEA041</b>	(1x) <b>140SDEA041</b> (2x) <b>91P052</b>	B1	B2	B5
	40	16	3/8" LOW PROFILE	1.3	57	<b>B57</b>	<b>160SDEA041</b>		B1	B2	B5
	45	18	3/8" LOW PROFILE	1.3	62	<b>B62</b>	<b>180SDEA041</b>		B1	B2	B5
KSE2400-35	35	14	3/8" LOW PROFILE	1.3	52	<b>B52</b>			B1	B2	B5
EKS 1500-35, BKS 4135, KSE2000-35, KSI1800-35, KSI1600-35, KSI1800, KSI1800-40	35	14	3/8" LOW PROFILE	1.3	52	<b>B52</b>	<b>140SDEA041</b>	(1x) <b>140SDEA041</b> (2x) <b>91P052</b>	B1	B2	B5
PKS 4240	40	16	3/8" LOW PROFILE	1.3	55	<b>B55</b>			B1	B2	B5
BKS 4141	40	16	3/8" LOW PROFILE	1.3	56	<b>B56</b>			B1	B2	B5
KSB3940, KSE2000, KSE2400-40, KSI2000, KSI2000-40, KSI2200	40	16	3/8" LOW PROFILE	1.3	56	<b>B56</b>	<b>160SDEA041</b>	(1x) <b>160SDEA041</b> (2x) <b>91P056</b>	B1	B2	B5
Top Craft EKS 1700	40	16	3/8" LOW PROFILE	1.3	57	<b>B57</b>			B1	B2	B5
KSI1600-40, KSI1800-40, PKS 1635, PKS1840, Swing 1840, PKS 4645, KSE2000-40, KSE2540LA	40	16	3/8" LOW PROFILE	1.3	57	<b>B57</b>	<b>160SDEA041</b>		B1	B2	B5
KSE2400, KSE2400-45, KSE2000-45, KSE2150	45	18	3/8" LOW PROFILE	1.3	62	<b>B62</b>			B1	B2	B5
KSB 4945	45	18	.325"	1.3	72	<b>D72</b>			D1	D2	D5
BKS 5146	45	18	.325"	1.5	72	<b>F72</b>			D1	D2	D5
JATT™											
YT4653	35	14	3/8" LOW PROFILE	1.3	52	<b>B52</b>	<b>140SDEA041</b>	(1x) <b>140SDEA041</b> (2x) <b>91P052</b>	B1	B2	B5
YT4774	40	16	3/8" LOW PROFILE	1.3	57	<b>B57</b>	<b>160SDEA041</b>		B1	B2	B5
JENN FENG™											
AC310114-35	35	14	3/8" LOW PROFILE	1.3	49	<b>B49</b>	<b>140SDEA318</b>		B1	B2	B5



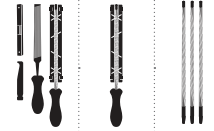
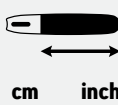

JOLLY™											
40 Garden Ranger	40	16	3/8" LOW PROFILE	1.3	56	B56			B1	B2	B5
JONSERED™											
370, 380, 2035, 2036**, 2040**, CS 2115EL, CS 2116EL, CS2117EL, CS 2118EL, CS2121EL, 2135, 2135T, 2138, 2139T, 2234*, 2236T, 2238*, 2238S	30	12	3/8" LOW PROFILE	1.3	45	B45	120SDEA095		B1	B2	B5
	35	14	3/8" LOW PROFILE	1.3	52	B52	140SDEA095		B1	B2	B5
* Until year 2009	40	16	3/8" LOW PROFILE	1.3	56	B56	160SDEA095		B1	B2	B5
** Model exist in more than one chain pitch	30	12	3/8" LOW PROFILE	1.3	45	B45	120SDEA041 (1x) 120SDEA041 (2x) 91P045		B1	B2	B5
2033TH, 2137, 2138, 2234*, 2238*	35	14	3/8" LOW PROFILE	1.3	52	B52	140SDEA041 (1x) 140SDEA041 (2x) 91P052		B1	B2	B5
* From year 2010	40	16	3/8" LOW PROFILE	1.3	57	B57	160SDEA041		B1	B2	B5
EL14, 45, 49SP, 50, 51, 52, 370, 380, 410, 420, 425, 435, 450, 451, 452, 455, 490, 520, 525, 535, 590, 2012, 2014, 2015, 2016, 2036**, 2040**, 2041, 2045, 2050, 2051, 2054, 2055, 2063, CS 2141, CS 2145, CS 2147, CS 2149, CS 2150, CS 2152, CS 2153, CS 2156, CS 2159, CS 2163, CS 2240, CS 2240 II, CS 2240S, CS 2240S II, CS 2245, CS 2245S, CS 2245 S II, CS 2250S, CS 2250S II, CS 2252, CS 2253, CS 2255, CS 2258, CS 2260	33	13	.325"	1.3	56	D56	130MLBK095 (1x) 130MLBK095 (2x) 95TXL056		D1	D2	D5
	38	15	.325"	1.3	64	D64	150MLBK095 (1x) 150MLBK095 (2x) 95TXL064		D1	D2	D5
	40	16	.325"	1.3	66	D66	160MLBK095		D1	D2	D5
	45	18	.325"	1.3	72	D72	180MLBK095 (1x) 180MLBK095 (2x) 95TXL072		D1	D2	D5
** Model exist in more than one chain pitch	50	20	.325"	1.3	78	D78	200TXLBK095		D1	D2	D5
EL1200, EL14, 45, 49SP, 50, 51, 52, 370, 380, 410, 420, 425, 435, 450, 451, 452, 455, 490, 510, 520, 525, 535, 590, 2012, 2014, 2015, 2036**, 2040**, 2041, 2045, 2050, 2051, 2054, 2055, 2063, CS 45E, CS 52E, CS 451, CS 2137, CS 2141, CS 2145, CS 2147, CS 2149, CS 2150, CS 2152, CS 2153, CS 2156**, CS 2159**, CS 2163**, CS 2240, CS 2245, CS 2250, CS 2252, CS 2253, CS 2255, CS 2258, CS 2260**	33	13	.325"	1.5	56	F56	138PXBK095 (1x) 138PXBK095 (2x) 21BPX056		D1	D2	D5
** Model exist in more than one chain pitch	38	15	.325"	1.5	64	F64	158PXBK095 (1x) 158PXBK095 (2x) 21BPX064		D1	D2	D5
Note: many saws fitted in .325 / 1.5mm (21) can be converted to SpeedCut narrow kerf .325 / 1.3mm (95) cutting system. In such a case, both the bar and chain have to be changed	40	16	.325"	1.5	66	F66			D1	D2	D5
	45	18	.325"	1.5	72	F72	188PXBK095 (1x) 188SFGK095 (2x) 21BPX072		D1	D2	D5
	50	20	.325"	1.5	78	F78	208PXBK095		D1	D2	D5
CS 2156**, CS 2159**, CS 2163**, CS 2260**	38	15	3/8"	1.5	56	73DPX056E	158VXLHK095		K1	K2	K5
** Model exist in more than one chain pitch	40	16	3/8"	1.5	60		168VXLHK095		K1	K2	K5
	45	18	3/8"	1.5	68	L68	188SFHK095		K1	K2	K5
	50	20	3/8"	1.5	72	L72	208VXLHK095		K1	K2	K5
	60	24	3/8"	1.5	84				K1	K2	K5
625, 630, 670, 670 Champ, 670 Super, 2065, 2071, 2077, 2083, 2094, 2095, 2165, 2171, 2172, 2186, 2188	38	15	3/8"	1.5	56	73DPX056E			K1	K2	K5
	45	18	3/8"	1.5	68	L68	188SFHD009 (1x) 188SFHD009 (2x) 73DPX068		K1	K2	K5
	50	20	3/8"	1.5	72	L72	208SFHD009 (1x) 208SFHD009 (2x) 73DPX072		K1	K2	K5
60, 92, 66, 70, 75, 77, 80, 81, 90, 110, 111, 601, 621, 751, 801, 820, 830, 910E, 920, 930, 941	45	18	3/8"	1.5	68	L68			K1	K2	K5
	50	20	3/8"	1.5	72	L72	208SFHD024		K1	K2	K5
KING CRAFT™											
BKS 4135, KSE 2000-35	35	14	3/8" LOW PROFILE	1.3	52	B52			B1	B2	B5
BKS 400-2.2	40	16	3/8" LOW PROFILE	1.3	54	160SDEA318			B1	B2	B5
BKS 4141, KSI 2000-40	40	16	3/8" LOW PROFILE	1.3	56	B56	160SDEA041 (1x) 160SDEA041 (2x) 91P056		B1	B2	B5
EKS 1600-40, EKS 1750 ab 6/2002, EKS 1800-40, KS 2000TF-40, KS 2000TS-40, KSE 2000-40, KSI 2000-40, KSI 2200, 1800/40	40	16	3/8" LOW PROFILE	1.3	57	B57			B1	B2	B5



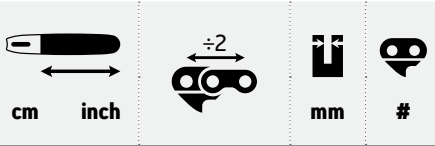

**MAC ALLISTER™ ./..**

Mac 45TT	42	18	.325"	1.5	72	<b>F72</b>	<b>188PXBK095</b>	(1x) <b>188SFGK095</b> (2x) <b>21BPX072</b>	D1	D2	D5
Mac 50CC	50	20	.325"	1.5	78	<b>F78</b>			D1	D2	D5
MCSWP50, TTL760CHN	50	20	.325"	1.5	78	<b>F78</b>	<b>208PXBK095</b>		D1	D2	D5

**MAKITA™**

UC002G**, UC003G**, UC004G**, UC005G**, UC007G**, UC010G**, UC011G**, UC012G**, UC013G**, UC014G**, UC015G**, UC016G**, UC017G** **Pitch and gauge may vary	30	12	.325" LOW PROFILE	1.1	51	<b>N51</b>	<b>124TXLNA041</b>		B1	B2	B5
DUA300Z**, DUA301Z**, UA004G** **Pitch and gauge may vary	30	12	3/8" LOW PROFILE	1.1	46	<b>A46</b>	<b>124MLEA041</b>		A1	A2	A5
BUC300, DCS 34, DUC254RF, DUC254RT2, DUC254Z, DUC300, DUC302, DUC302Z, DUC307, DUC357, DUC407 DUC353Z*, DUC353RF2*, DUC355Z, EA3200S*, EA3201S*, EA3202S*, EA3203S*, EA3500S*, EA3501S*, EA3502S*, EA3503S*, UC002G**, UC003G**, UC004G**, UC005G**, UC007G**, UC010G**, UC011G**, UC012G**, UC013G**, UC014G**, UC015G**, UC016G**, UC017G**, UC300D, UC3010A, UC3020A*, UC3040A*, UC3041A*, UC3510A, UC3520A*, UC3540A*, UC3541A*, UC3551A*, UC4010A, UC4020A*, UC4040A*, UC4041A*, UC4051AK *Gauge may vary and be 1.3mm **Pitch and gauge may vary	25	10	3/8" LOW PROFILE	1.1	40	<b>A40</b>			A1	A2	A5
DUA300Z**, DUA301Z**, UA004G** **Pitch and gauge may vary	30	12	3/8" LOW PROFILE	1.1	46	<b>A46</b>	<b>124MLEA041</b>		A1	A2	A5
DUA300Z**, DUA301Z**, UA004G** **Pitch and gauge may vary	30	12	3/8" LOW PROFILE	1.1	52	<b>A52</b>	<b>144MLEA041</b>		A1	A2	A5
DUA300Z**, DUA301Z**, UA004G** **Pitch and gauge may vary	40	16	3/8" LOW PROFILE	1.1	56	<b>A56</b>	<b>164MLEA041</b>		A1	A2	A5
DUA300Z**, DUA301Z**, UA004G** **Pitch and gauge may vary	30	12	3/8" LOW PROFILE	1.3	46	<b>B46</b>	<b>120SDEA041</b>		B1	B2	B5
3500A, 4000A, 5012B, BUC250, BUC250RDE, BUC250Z, DCS33, DCS34, DCS221TH, DCS230T, DCS231T, DCS232T, DCS330TH, DCS330/S, DCS340, DCS341, DCS344, DCS350, DCS380, DCS390, DCS400, DCS401, DCS2501, DCS3400, DCS3400TH, DCS3410, DCS3410TH, DCS3500, DCS3501, DCS4300i, DCS4610, DES300, DES330S, DES340, DES341, DES350, DES380, DES390, DES400, DES401, DUC252, DUC252PM4, DUC252RM2, DUC252Z, DUC353Z*, DUC353RF2*, DUC254, DUC306PT2B, DUC306ZB, DUC356PT2B, DUC356ZB, EA3100T, EA3110T, EA3200S, EA3200S, EA3200S*, EA3201S*, EA3202S*, EA3203S*, EA3500F, EA3500S*, EA3501F, EA3501S*, EA3502S*, EA3503S*, EA3600F, EA3601F, EA3700T, EA4300F, UA004G**, UC002G**, UC003G**, UC004G**, UC005G**, UC007G**, UC010G**, UC011G**, UC012G**, UC013G**, UC014G**, UC015G**, UC016G**, UC017G**, UC250D, UC3001A, UC3020A*, UC3030A, UC3040A*, UC3041A*, UC3050A, UC3051A, UC3501A, UC3520A*, UC3530A, UC3530AP, UC3540A*, UC3541A*, UC3550A, UC3551A*, UC4001A, UC4020A*, UC4030A, UC4030AP, UC4040A*, UC4041A*, UC4050A, UC4051A, UC4530A, UC4530AP, UC4550A, UC4551A, VC3000A *Gauge can vary and be 1.1mm **Pitch and gauge may vary	25	10	3/8" LOW PROFILE	1.3	40	<b>B40</b>	<b>100SDEA041</b>		B1	B2	B5
DUA300Z**, DUA301Z**, UA004G** **Pitch and gauge may vary	30	12	3/8" LOW PROFILE	1.3	46	<b>B46</b>	<b>120SDEA041</b>		B1	B2	B5
DUA300Z**, DUA301Z**, UA004G** **Pitch and gauge may vary	35	14	3/8" LOW PROFILE	1.3	52	<b>B52</b>	<b>140SDEA041</b>	(1x) <b>140SDEA041</b> (2x) <b>91P052</b>	B1	B2	B5
DUA300Z**, DUA301Z**, UA004G** **Pitch and gauge may vary	40	16	3/8" LOW PROFILE	1.3	56	<b>B56</b>	<b>160SDEA041</b>	(1x) <b>160SDEA041</b> (2x) <b>91P056</b>	B1	B2	B5
DUA300Z**, DUA301Z**, UA004G** **Pitch and gauge may vary	45	18	3/8" LOW PROFILE	1.3	62	<b>B62</b>	<b>180SDEA041</b>		B1	B2	B5
DCS410, DCS411, DCS430, DCS520, DCS4300, DCS4300i, DCS4300F45C-KIT, DCS4301, DCS4301-KIT, DCS5200i, EA4300F, EA4301F	33	13	.325"	1.3	56	<b>D56</b>	<b>130MLBK041</b>		D1	D2	D5
	38	15	.325"	1.3	64	<b>D64</b>	<b>150MLBK041</b>		D1	D2	D5
	45	18	.325"	1.3	72	<b>D72</b>	<b>180MLBK041</b>		D1	D2	D5

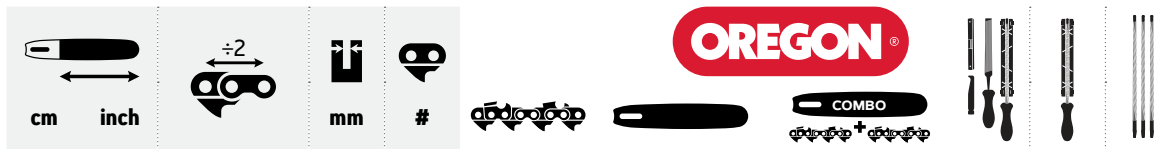
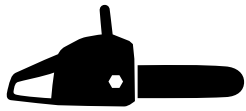

**MAKITA™ /../**

DCS43, DCS52, DCS430, DCS431, DCS460, DCS461, DCS500, DCS501, DCS520, DCS4300i, DCS4600S, DCS4600SH, DCS4630, DCS4630-38, DCS5000, DCS5000H, DCS5001, DCS5001H, DCS5121, DCS5200, DCS5200i, DCS6000i, DCS6800i, EA500F, EA5000P, EA5001F, EA5001P	33	13	.325"	1.5	56	<b>F56</b>	<b>138PXBK095</b>	(1x) <b>138PXBK095</b> (2x) <b>21BPX056</b>	D1	D2	D5
Above models can also be fitted in 3/8" pitch	38	15	.325"	1.5	64	<b>F64</b>	<b>158PXBK095</b>	(1x) <b>158PXBK095</b> (2x) <b>21BPX064</b>	D1	D2	D5
	40	16	.325"	1.5	66	<b>F66</b>	<b>168PXBK095</b>		D1	D2	D5
	45	18	.325"	1.5	72	<b>F72</b>	<b>188PXBK095</b>	(1x) <b>188SFGK095</b> (2x) <b>21BPX072</b>	D1	D2	D5
DCS6000I, DCS6100P, DCS6101P, DCS6400, DCS6400H, DCS6401, DCS6401-45, DCS7300, DCS7300H, DCS7300P, DCS7301, DCS7301P, DCS7301-45, DCS7900, DCS7900H, DCS7900P, DCS7901, DCS7901P, DCS9000, DCS9010, EA5600F, EA7300P, EA7900P	38	15	3/8"	1.5	56	<b>73DPX056E</b>	<b>158SFHDO09</b>	(1x) <b>158SFHDO09</b> (2x) <b>73DPX056</b>	K1	K2	K5
	40	16	3/8"	1.5	60		<b>168SFHDO09</b>		K1	K2	K5
	43	17	3/8"	1.5	64	<b>73DPX064E</b>			K1	K2	K5
	45	18	3/8"	1.5	68	<b>L68</b>	<b>188SFHDO09</b>	(1x) <b>188SFHDO09</b> (2x) <b>73DPX068</b>	K1	K2	K5
	50	20	3/8"	1.5	72	<b>L72</b>	<b>208SFHDO09</b>	(1x) <b>208SFHDO09</b> (2x) <b>73DPX072</b>	K1	K2	K5

**MATRIX™**

Pole Saw EPS850	20	8	3/8" LOW PROFILE	1.3	33	<b>B33</b>			B1	B2	B5
ECS2000-400, ECS2000-400, EK 2000-400-1, EK2200-40	40	16	3/8" LOW PROFILE	1.3	56	<b>B56</b>	<b>160SDEA041</b>	(1x) <b>160SDEA041</b> (2x) <b>91P056</b>	B1	B2	B5
	40	16	3/8" LOW PROFILE	1.3	57	<b>B57</b>	<b>160SDEA041</b>		B1	B2	B5
EK2400-40AK	40	16	3/8" LOW PROFILE	1.3	57	<b>B57</b>	<b>160SDEA041</b>		B1	B2	B5
PCS46-45, MCS46-45	45	18	3/8" LOW PROFILE	1.3	62	<b>B62</b>			B1	B2	B5
SPS01-45	45	18	.325"	1.5	72	<b>F72</b>			D1	D2	D5

**MAX BAHR™**

Pole Saw KSH600	25	10	3/8" LOW PROFILE	1.3	40	<b>B40</b>			B1	B2	B5
	35	14	3/8" LOW PROFILE	1.3	52	<b>B52</b>	<b>140SDEA041</b>	(1x) <b>140SDEA041</b> (2x) <b>91P052</b>	B1	B2	B5
KSB3940, KSE2000, KSE2150, KSI1800-35	40	16	3/8" LOW PROFILE	1.3	56	<b>B56</b>	<b>160SDEA041</b>	(1x) <b>160SDEA041</b> (2x) <b>91P056</b>	B1	B2	B5
	45	18	3/8" LOW PROFILE	1.3	62	<b>B62</b>	<b>180SDEA041</b>		B1	B2	B5
KSB 4945	45	18	.325"	1.3	72	<b>D72</b>			D1	D2	D5

**MCCULLOCH™**

Li58CS	40	16	3/8" LOW PROFILE	1.1	56	<b>A56</b>	<b>164MLEA041</b>		A1	A2	A5
CS35, CS 35S, CS 42S, CS 42 STE, CS330, CS340, CS340-16, CS350, CS360, CS360T, CS370, CS380, CS380T, CS390, CS400, CS400T, CS420T, CSE 1835, CSE 1935S, CSE 2020, CSE 2040S, CSE 2040, Inline 1650, Inline 1800, Inline 1800T, Inline 1900, Inline 2200T, MAC 4-18XT, Mac 4-20 XT, Mac 20X Power, Mac 335, Mac 435, MAC418XT, Mac Cat 436, Mac Cat 438, Mac Cat 440, Mac Cat 441, Mac Cat T441, Mac Cat 442, Titanium 420, MAC842	35	14	3/8" LOW PROFILE	1.3	52	<b>B52</b>	<b>140SDEA041</b>	(1x) <b>140SDEA041</b> (2x) <b>91P052</b>	B1	B2	B5
	40	16	3/8" LOW PROFILE	1.3	56	<b>B56</b>	<b>160SDEA041</b>	(1x) <b>160SDEA041</b> (2x) <b>91P056</b>	B1	B2	B5
	45	18	3/8" LOW PROFILE	1.3	62	<b>B62</b>	<b>180SDEA041</b>		B1	B2	B5
CS50S, CS410, CS410T, CS 410 Elite, CS 410 Elite 15, CS450, CS450 elite, CS450 Elite 18, Promac 10-42, Promac 10-49, Xtreme 3.0, Xtreme 3.4	33	13	.325"	1.3	56	<b>D56</b>	<b>130MLBK095</b>	(1x) <b>130MLBK095</b> (2x) <b>95TXL056</b>	D1	D2	D5
	38	15	.325"	1.3	64	<b>D64</b>	<b>150MLBK095</b>	(1x) <b>150MLBK095</b> (2x) <b>95TXL064</b>	D1	D2	D5
	45	18	.325"	1.3	72	<b>D72</b>	<b>180MLBK095</b>	(1x) <b>180MLBK095</b> (2x) <b>95TXL072</b>	D1	D2	D5

**MEEC TOOLS™**

GRENSÅG MEEC EL 900W	25	10	3/8" LOW PROFILE	1.3	40	<b>B40</b>	<b>100SDEA041</b>		B1	B2	B5
GRENSÅG MEEC	30	12	3/8" LOW PROFILE	1.3	45	<b>B45</b>	<b>120SDEA041</b>	(1x) <b>120SDEA041</b> (2x) <b>91P045</b>	B1	B2	B5
ELKEDJESÅG 2200W, 1600W,	35	14	3/8" LOW PROFILE	1.3	52	<b>B52</b>	<b>140SDEA041</b>	(1x) <b>140SDEA041</b> (2x) <b>91P052</b>	B1	B2	B5
MEEC 37.2CC	35	14	3/8" LOW PROFILE	1.3	53	<b>B53</b>	<b>140SDEA041</b>		B1	B2	B5
ELKEDJESÅG 2000W	40	16	3/8" LOW PROFILE	1.3	57	<b>B57</b>	<b>160SDEA041</b>		B1	B2	B5
MEEC MOTORSÅG 46CC	33	13	.325"	1.3	56	<b>D56</b>	<b>130MLBK095</b>	(1x) <b>130MLBK095</b> (2x) <b>95TXL056</b>	D1	D2	D5
MEEC MOTORSÅG 49.3CC	40	16	.325"	1.5	66	<b>F66</b>	<b>168PXBK095</b>		D1	D2	D5

**MEROX™**

EK 2400-400WLK	40	16	3/8" LOW PROFILE	1.3	56	<b>B56</b>	<b>160SDEA041</b>	(1x) <b>160SDEA041</b> (2x) <b>91P056</b>	B1	B2	B5
EKS2040/1	40	16	3/8" LOW PROFILE	1.3	57	<b>B57</b>	<b>160SDEA041</b>		B1	B2	B5



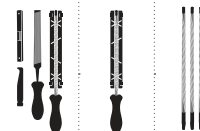
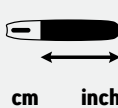

METABO™											
5338	30	12	3/8" LOW PROFILE	1.3	44	<b>B44</b>	<b>120SDEA074</b>	(1x) <b>120SDEA074</b> (2x) <b>91P044</b>	B1	B2	B5
	35	14	3/8" LOW PROFILE	1.3	50	<b>B50</b>	<b>140SDEA074</b>	(1x) <b>140SDEA074</b> (2x) <b>91P050</b>	B1	B2	B5
	40	16	3/8" LOW PROFILE	1.3	55	<b>B55</b>	<b>160SDEA074</b>	(1x) <b>160SDEA074</b> (2x) <b>91P055</b>	B1	B2	B5
KT1441	40	16	3/8" LOW PROFILE	1.3	57	<b>B57</b>	<b>160SDEA095</b>		B1	B2	B5
1530	33	13	.325"	1.5	56	<b>F56</b>	<b>138PXBK095</b>	(1x) <b>138PXBK095</b> (2x) <b>21BPX056</b>	D1	D2	D5
MOGATEC™											
MKS3835	35	14	3/8" LOW PROFILE	1.3	49	<b>B49</b>	<b>140SDEA318</b>		B1	B2	B5
EKS1500-35	35	14	3/8" LOW PROFILE	1.3	52	<b>B52</b>	<b>140SDEA041</b>	(1x) <b>140SDEA041</b> (2x) <b>91P052</b>	B1	B2	B5
MOUNTFIELD™											
MC2000Q, MC3616, MC3720, MC438, MC48LI	35	14	3/8" LOW PROFILE	1.3	52	<b>B52</b>	<b>140SDEA041</b>	(1x) <b>140SDEA041</b> (2x) <b>91P052</b>	B1	B2	B5
	40	16	3/8" LOW PROFILE	1.3	57	<b>B57</b>	<b>160SDEA041</b>		B1	B2	B5
MC382	40	16	.325"	1.3	66	<b>D66</b>			D1	D2	D5
MC640	40	16	.325"	1.3	66	<b>E66</b>			D1	D2	D5
MR. GARDENER™											
1335-2 WKS, AKS 4035 LI	35	14	3/8" LOW PROFILE	1.3	52	<b>B52</b>			B1	B2	B5
EKS1835, EKS1835/2	35	14	3/8" LOW PROFILE	1.3	53	<b>B53</b>	<b>140SDEA041</b>	(1x) <b>140SDEA041</b> (2x) <b>91P052</b>	B1	B2	B5
BKS2040, EKS2040/1, EKS2440	40	16	3/8" LOW PROFILE	1.3	57	<b>B57</b>	<b>160SDEA041</b>		B1	B2	B5
MTD™											
GCS25/30T	30	12	3/8" LOW PROFILE	1.3	45	<b>B45</b>			B1	B2	B5
CC1936, CC2740	35	14	3/8" LOW PROFILE	1.3	52	<b>B52</b>	<b>140SDEA095</b>		B1	B2	B5
	40	16	3/8" LOW PROFILE	1.3	56	<b>B56</b>	<b>160SDEA095</b>		B1	B2	B5
CC3045, 3352, 3551, 4051, 4256	33	13	.325"	1.5	56	<b>F56</b>	<b>138PXBK095</b>	(1x) <b>138PXBK095</b> (2x) <b>21BPX056</b>	D1	D2	D5
	38	15	.325"	1.5	64	<b>F64</b>	<b>158PXBK095</b>	(1x) <b>158PXBK095</b> (2x) <b>21BPX064</b>	D1	D2	D5
	40	16	.325"	1.5	60		<b>168PXBK095</b>		D1	D2	D5
	45	18	.325"	1.5	72	<b>F72</b>	<b>188PXBK095</b>	(1x) <b>188SFGK095</b> (2x) <b>21BPX072</b>	D1	D2	D5
NAC™											
CST25-25-08AC	25	10	3/8" LOW PROFILE	1.3	40	<b>B40</b>	<b>100SDEA041</b>		B1	B2	B5
CE18-N-H, NAC4380, NAC4645	35	14	3/8" LOW PROFILE	1.3	52	<b>B52</b>	<b>140SDEA041</b>	(1x) <b>140SDEA041</b> (2x) <b>91P052</b>	B1	B2	B5
	40	16	3/8" LOW PROFILE	1.3	57	<b>B57</b>	<b>160SDEA041</b>		B1	B2	B5
E20-NS-H	40	16	3/8" LOW PROFILE	1.3	56	<b>B56</b>	<b>160SDEA041</b>	(1x) <b>160SDEA041</b> (2x) <b>91P056</b>	B1	B2	B5
CST38-40-06AC	40	16	.325"	1.3	66	<b>E66</b>	<b>160PXBK095</b>		D1	D2	D5
SPS01-45	45	18	.325"	1.5	72	<b>F72</b>	<b>188PXBK095</b>	(1x) <b>188SFGK095</b> (2x) <b>21BPX072</b>	D1	D2	D5
NAREX™											
EPR-30 D-C, EPR30-20, EPR35-20, EPR-35 D-C, EPR35E, EPR-40 D-C, EPR40-20	30	12	3/8" LOW PROFILE	1.3	45	<b>B45</b>	<b>120SDEA041</b>	(1x) <b>120SDEA041</b> (2x) <b>91P045</b>	B1	B2	B5
	30	14	3/8" LOW PROFILE	1.3	52	<b>B52</b>	<b>140SDEA041</b>	(1x) <b>140SDEA041</b> (2x) <b>91P052</b>	B1	B2	B5
	40	16	3/8" LOW PROFILE	1.3	57	<b>B57</b>	<b>160SDEA041</b>		B1	B2	B5
EPR35-23	35	14	3/8" LOW PROFILE	1.3	53	<b>B53</b>			B1	B2	B5
EPR40-23	40	16	3/8" LOW PROFILE	1.3	57	<b>B57</b>			B1	B2	B5
NAUTAC™											
135,140,144,232,236	30	12	3/8" LOW PROFILE	1.3	44	<b>B44</b>			B1	B2	B5
	35	14	3/8" LOW PROFILE	1.3	49	<b>B49</b>			B1	B2	B5
	40	16	3/8" LOW PROFILE	1.3	56	<b>B56</b>			B1	B2	B5
131	35	14	3/8" LOW PROFILE	1.3	52	<b>B52</b>	<b>140SDEA041</b>	(1x) <b>140SDEA041</b> (2x) <b>91P052</b>	B1	B2	B5
138	33	13	.325"	1.3	56	<b>D56</b>	<b>130MLBK095</b>	(1x) <b>130MLBK095</b> (2x) <b>95TXL056</b>	D1	D2	D5
	38	15	.325"	1.3	64	<b>D64</b>	<b>150MLBK095</b>	(1x) <b>150MLBK095</b> (2x) <b>95TXL064</b>	D1	D2	D5
	45	18	.325"	1.3	72	<b>D72</b>	<b>180MLBK095</b>	(1x) <b>180MLBK095</b> (2x) <b>95TXL072</b>	D1	D2	D5



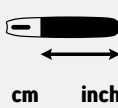

### OLEO-MAC™ ./..

	33	13	.325"	1.3	56	<b>D56</b>	<b>130MLBK095</b>	(1x) <b>130MLBK095</b> (2x) <b>95TXL056</b>	D1	D2	D5
GSH 51*, GSH 56*, GSH 510*, GSH 560*	38	15	.325"	1.3	64	<b>D64</b>	<b>150MLBK095</b>	(1x) <b>150MLBK095</b> (2x) <b>95TXL064</b>	D1	D2	D5
* Pitch and/or gauge may vary	40	16	.325"	1.3	66	<b>D66</b>	<b>160MLBK095</b>		D1	D2	D5
	45	18	.325"	1.3	72	<b>D72</b>	<b>180MLBK095</b>	(1x) <b>180MLBK095</b> (2x) <b>95TXL072</b>	D1	D2	D5
938, 947, 952, 956*, 962*, GSH 51*, GSH 56*, GSH 510*, GS 520, GSH 560*, GS 630*	33	13	.325"	1.5	56	<b>F56</b>	<b>138PXBK095</b>	(1x) <b>138PXBK095</b> (2x) <b>21BPX056</b>	D1	D2	D5
* Pitch and/or gauge may vary	38	15	.325"	1.5	64	<b>F64</b>	<b>158PXBK095</b>	(1x) <b>158PXBK095</b> (2x) <b>21BPX064</b>	D1	D2	D5
	40	16	.325"	1.5	66	<b>F66</b>	<b>168PXBK095</b>		D1	D2	D5
	45	18	.325"	1.5	72	<b>F72</b>	<b>188PXBK095</b>	(1x) <b>188SFGK095</b> (2x) <b>21BPX072</b>	D1	D2	D5
	50	20	.325"	1.5	78	<b>F78</b>	<b>208PXBK095</b>		D1	D2	D5
956*, 962*, 965 HD, GSH 51*, GSH 56*, GSH 510*, GSH 560*, GS 630*	45	18	3/8"	1.5	68	<b>L68</b>	<b>188SFHK095</b>		K1	K2	K5
* Pitch and/or gauge may vary	50	20	3/8"	1.5	72	<b>L72</b>	<b>208VXLHK095</b>		K1	K2	K5
GS 650, GS 651	45	18	3/8"	1.5	68	<b>L68</b>	<b>188SFHD009</b>	(1x) <b>188SFHD009</b> (2x) <b>73DPX068</b>	K1	K2	K5
	50	20	3/8"	1.5	72	<b>L72</b>	<b>208SFHD009</b>	(1x) <b>208SFHD009</b> (2x) <b>73DPX072</b>	K1	K2	K5
261, 264, 350, 481, 482, GS 720, GS 820	45	18	3/8"	1.5	68	<b>L68</b>			K1	K2	K5
	50	20	3/8"	1.5	72	<b>L72</b>	<b>208SFHD024</b>		K1	K2	K5

### OREGON™

PS250	20	8	3/8" LOW PROFILE	1.1	34	<b>90PX034E</b>	<b>084MLEA041</b>		A1	A2	A5
PS750	20	8	3/8" LOW PROFILE	1.3	33	<b>B33</b>	<b>080SDEA041</b>		B1	B2	B5
CS1200	35	14	3/8" LOW PROFILE	1.3	52	<b>B52</b>	<b>140SDEA041</b>	(1x) <b>140SDEA041</b> (2x) <b>91P052</b>	B1	B2	B5
CS1400	40	16	3/8" LOW PROFILE	1.3	56	<b>B56</b>	<b>160SDEA041</b>	(1x) <b>160SDEA041</b> (2x) <b>91P056</b>	B1	B2	B5
CS1500	40	16	3/8" LOW PROFILE	1.3	56	<b>573268</b>	<b>160SDEA041</b>				
	45	18	3/8" LOW PROFILE	1.3	62	<b>571039</b>	<b>180SDEA041</b>				
CS250	35	14	3/8" LOW PROFILE	1.3	52	<b>566336</b>	<b>140SDEA041</b>				
CS300	40	16	3/8" LOW PROFILE	1.3	56	<b>573268</b>	<b>160SDEA041</b>				

### PARKSIDE™

EKS 1650, EKS 1700/40, PKS 40, PKS 40/3, EKS 1700/40 ab 4/2002	40	16	3/8" LOW PROFILE	1.1	55				A1	A2	A5
EKS 1600, EKS1650, EKS 1800, EKS 2500/5, EKS 2500/5QT	35	14	3/8" LOW PROFILE	1.3	49	<b>B49</b>	<b>140SDEA318</b>		B1	B2	B5
	40	16	3/8" LOW PROFILE	1.3	55	<b>B55</b>			B1	B2	B5
PKS 200/4, PKS 40, PKS 40/3	40	16	3/8" LOW PROFILE	1.3	55	<b>B55</b>	<b>160SDEA318</b>		B1	B2	B5
EKS 1700	40	16	3/8" LOW PROFILE	1.3	56	<b>B56</b>			B1	B2	B5
PKS 40/5, PKS 1635, PKS 1840	40	16	3/8" LOW PROFILE	1.3	57	<b>B57</b>			B1	B2	B5

### PARTNER™

1436, 1641	35	14	3/8" LOW PROFILE	1.1	52	<b>A52</b>			A1	A2	A5
	40	16	3/8" LOW PROFILE	1.1	56	<b>A56</b>			A1	A2	A5
(P) 330, 335, 340, 345, 350, 351, 352, 360, 365, 370, 371, 382, 385, 390, 391, 395, 401, 405, 420*, 422, 436, 470, 516, 719, 738, 740, 842, 842 CC, 842 Combi, 542, 542e, 1436, 1535, 1550, 1641, 1750 ELP, 1840, 1850, 20X, 33XT, 352 CCS, 382 CCS, 4-18XT, P4-18, 4-20XT, P4-20, 842TL, EL1200, EL1400, EL1435, EL1440, EL1500, Formula 55, Formula 60, Formula 400, ES716, ES718, ES720, ES722	30	12	3/8" LOW PROFILE	1.3	45	<b>B45</b>	<b>120SDEA041</b>	(1x) <b>120SDEA041</b> (2x) <b>91P045</b>	B1	B2	B5
* From year 2010	35	14	3/8" LOW PROFILE	1.3	52	<b>B52</b>	<b>140SDEA041</b>	(1x) <b>140SDEA041</b> (2x) <b>91P052</b>	B1	B2	B5
	40	16	3/8" LOW PROFILE	1.3	56	<b>B56</b>	<b>160SDEA041</b>	(1x) <b>160SDEA041</b> (2x) <b>91P056</b>	B1	B2	B5
	45	18	3/8" LOW PROFILE	1.3	62	<b>B62</b>	<b>180SDEA041</b>		B1	B2	B5
(P) 538, 538E, 1835, 1840, (P)1535EL, (P)1540EL, (P)1640EL, ES1900, ES2200	35	14	3/8" LOW PROFILE	1.3	50	<b>B50</b>	<b>140SDEA318</b>		B1	B2	B5
	40	16	3/8" LOW PROFILE	1.3	54		<b>160SDEA318</b>		B1	B2	B5
	45	18	3/8" LOW PROFILE	1.3	60		<b>180SDEA318</b>		B1	B2	B5
185, 1550EL, 1850EL, P420*, P520, P616, 620, P718T, P722T	35	14	3/8" LOW PROFILE	1.3	52	<b>B52</b>	<b>140SDEA095</b>		B1	B2	B5
* Until year 2009	40	16	3/8" LOW PROFILE	1.3	57	<b>B57</b>	<b>160SDEA095</b>		B1	B2	B5

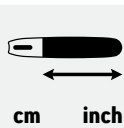
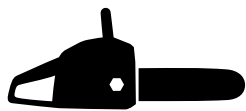

### PARTNER ./. .

20X POWER, EL1450, EL1650, (P) 360, 365, 400, 405, 410, 411, 450, 460, 461, 462, 462CCS, 465, 470, 490, 495, 500, 510, 511, 540, P540H, 543, 545, 605, 4700, 1200EL, 1400EL, 1450EL, 1500EL, 1650EL, Minifarmersaw, P4200, P4600, P4700, P4900, P5000, P5100, P5200, P5300, P5500	33	13	.325"	1.3	56	<b>D56</b>	<b>130MLBK095</b>	(1x) <b>130MLBK095</b> (2x) <b>95TXL056</b>	D1	D2	D5
	38	15	.325"	1.3	64	<b>D64</b>	<b>150MLBK095</b>	(1x) <b>150MLBK095</b> (2x) <b>95TXL064</b>	D1	D2	D5
	45	18	.325"	1.3	72	<b>D72</b>	<b>180MLBK095</b>	(1x) <b>180MLBK095</b> (2x) <b>95TXL072</b>	D1	D2	D5
20X POWER, EL1450, EL1650, (P) 360, 365, 400, 405, 410, 411, 450, 460, 461, 462, 462CCS, 465, 470, 490, 495, 500, 510, 511, 540, P540H, 543, 545, 605, 4700, P411, P461, P462, 1200EL, 1400EL, 1450EL, 1500EL, 1650EL, Minifarmersaw P462CCS, P500, P511, P540H, P543, P4200, P4600, P4700, P4900, P5000, P5100, P5200, P5300, P5500	33	13	.325"	1.5	56	<b>F56</b>	<b>138PXBK095</b>	(1x) <b>138PXBK095</b> (2x) <b>21BPX056</b>	D1	D2	D5
	38	15	.325"	1.5	64	<b>F64</b>	<b>158PXBK095</b>	(1x) <b>158PXBK095</b> (2x) <b>21BPX064</b>	D1	D2	D5
	40	16	.325"	1.5	66	<b>F66</b>	<b>168PXBK095</b>		D1	D2	D5
Note: many saws fitted in .325 / 1.5mm (21) can be converted to SpeedCut narrow kerf .325 / 1.3mm (95) cutting system. In such a case, both the bar and chain have to be changed	45	18	.325"	1.5	72	<b>F72</b>	<b>188PXBK095</b>	(1x) <b>188SFGK095</b> (2x) <b>21BPX072</b>	D1	D2	D5

### PATTFIELD™

E-EAS610, E-EAS620,	20	8	3/8" LOW PROFILE	1.1	33	<b>A33</b>			A1	A2	A5
PE-AHE 18 Li / 20 Li, PE-EAS	20	8	3/8" LOW PROFILE	1.3	33	<b>B33</b>			B1	B2	B5
E-KS2035, PE-EKS 1835	35	14	3/8" LOW PROFILE	1.3	52	<b>B52</b>	<b>140SDEA041</b>	(1x) <b>140SDEA041</b> (2x) <b>91P052</b>	B1	B2	B5
PE-BKS3735	35	14	3/8" LOW PROFILE	1.3	53	<b>B53</b>	<b>140SDEA041</b>		B1	B2	B5
PE-BKS4645	45	18	3/8" LOW PROFILE	1.3	61	<b>B61</b>			B1	B2	B5

### PERFORMANCE POWER™

FPCSP25, PP2525CSP	25	10	3/8" LOW PROFILE	1.3	40	<b>B40</b>			B1	B2	B5
FPCSP38, FPCS1800, FPCS1800A, YT 4750	35	14	3/8" LOW PROFILE	1.3	52	<b>B52</b>	<b>140SDEA041</b>	(1x) <b>140SDEA041</b> (2x) <b>91P052</b>	B1	B2	B5
PP1800, PP40CCEPA2, PP 41YD-KU01-41, YT 4770, YT 4998	40	16	3/8" LOW PROFILE	1.3	57	<b>B57</b>	<b>160SDEA041</b>		B1	B2	B5
PP 45YD-KU01-45	45	18	3/8" LOW PROFILE	1.3	60		<b>180SDEA318</b>		B1	B2	B5

### PEUGEOT™

TLS1630, TLS1635, TLS1635A, TLS1640, TRC1630, TRC1635, TRC1640	30	12	3/8" LOW PROFILE	1.3	45	<b>B45</b>			B1	B2	B5
	35	14	3/8" LOW PROFILE	1.3	50	<b>B50</b>			B1	B2	B5
	40	16	3/8" LOW PROFILE	1.3	56	<b>B56</b>			B1	B2	B5
EKS 1740	40	16	3/8" LOW PROFILE	1.3	56	<b>B56</b>			B1	B2	B5

### PLANTIFLOR™

Pole Saw ETK750	20	8	3/8" LOW PROFILE	1.3	33	<b>B33</b>			B1	B2	B5
BK 1,9-40	40	16	3/8" LOW PROFILE	1.3	54		<b>160SDEA318</b>		B1	B2	B5
KSE2400, KSI2000	40	16	3/8" LOW PROFILE	1.3	56	<b>B56</b>	<b>160SDEA041</b>	(1x) <b>160SDEA041</b> (2x) <b>91P056</b>	B1	B2	B5
	45	18	3/8" LOW PROFILE	1.3	62	<b>B62</b>			B1	B2	B5
BK 2,3-45	45	18	3/8" LOW PROFILE	1.3	60	<b>91P060E</b>			B1	B2	B5
BK 50-45	45	18	.325"	1.5	72	<b>F72</b>	<b>188PXBK095</b>	(1x) <b>188SFGK095</b> (2x) <b>21BPX072</b>	D1	D2	D5

### POULAN™

ES300	35	14	3/8" LOW PROFILE	1.1	52	<b>A52</b>			A1	A2	A5
	40	16	3/8" LOW PROFILE	1.1	56	<b>A56</b>			A1	A2	A5
	30	12	3/8" LOW PROFILE	1.3	45	<b>B45</b>	<b>120SDEA041</b>	(1x) <b>120SDEA041</b> (2x) <b>91P045</b>	B1	B2	B5
1800, 2000, 2300AV, 2300CVA, 25A, MICRO25, S25CVA, S25D, S25DA, P600, 2050, 2100, 2150, 2250, 2400, 2450, 2550, 2600, ESV1414-1450W, Woodshark 1400W, 36cc	35	14	3/8" LOW PROFILE	1.3	52	<b>B52</b>	<b>140SDEA041</b>	(1x) <b>140SDEA041</b> (2x) <b>91P052</b>	B1	B2	B5
	40	16	3/8" LOW PROFILE	1.3	56	<b>B56</b>	<b>160SDEA041</b>	(1x) <b>160SDEA041</b> (2x) <b>91P056</b>	B1	B2	B5
	45	18	3/8" LOW PROFILE	1.3	62	<b>B62</b>			B1	B2	B5
1600W	40	16	3/8" LOW PROFILE	1.3	57	<b>B57</b>	<b>160SDEA041</b>		B1	B2	B5
	33	13	.325"	1.3	56	<b>D56</b>			D1	D2	D5
2800, 2900, 3300, 3350	38	15	.325"	1.3	64	<b>D64</b>			D1	D2	D5
	45	18	.325"	1.3	72	<b>D72</b>			D1	D2	D5



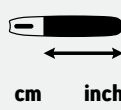

POWER FORCE™	cm	inch	mm	#	B55	160SDEA041	B1	B2	B5		
AC311076	40	16	3/8" LOW PROFILE	1.3	55						
POWER G™	PCS 38Z	40	16	3/8" LOW PROFILE	1.3	57	B57	160SDEA041	B1	B2	B5
POWER PLUS™	XG 1013	35	14	3/8" LOW PROFILE	1.3	52	B52		B1	B2	B5
XG 64111	40	16	3/8" LOW PROFILE	1.3	56	B56		B1	B2	B5	
PRIMASTER™	Akku PMAKS 20/40	35	14	3/8" LOW PROFILE	1.1	52	A52	144MLEA041	A1	A2	A5
PMA5 750	20	8	3/8" LOW PROFILE	1.3	33	B33		B1	B2	B5	
PRO WORK™	PEK 1840	40	16	3/8" LOW PROFILE	1.3	55	B55	160SDEA318	B1	B2	B5
1840	40	16	3/8" LOW PROFILE	1.3	57	B57	160SDEA041	B1	B2	B5	
REMINGTON™	1300	35	14	3/8" LOW PROFILE	1.3	50	B50		B1	B2	B5
RYOBI™	OPP1820, OPS1820Li, RPP720, RPP1815S, RPP182015, RPP182015S, RPP1820Li, RPP182020, RPP182025, RPP182025F, RY18CS20A	20	8	3/8" LOW PROFILE	1.1	33	A33	084MLEA041	A1	A2	A5
RPP720, RPP755E, RPP750450	25	10	3/8" LOW PROFILE	1.1	40	A40		A1	A2	A5	
OCS1830, RCS36, RCS36 AKKU, RCS1830 Akku, RCS18X3050F	30	12	3/8" LOW PROFILE	1.1	45	A45	124MLEA041	A1	A2	A5	
RY36CSX35A-0, RY36CSX35A-150, RCS36X3550HI	35	14	3/8" LOW PROFILE	1.1	52	A52		A1	A2	A5	
RPP750S, RPP755E	20	8	3/8" LOW PROFILE	1.3	33	B33	080SDEA041	B1	B2	B5	
	25	10	3/8" LOW PROFILE	1.3	40	B40	100SDEA041	B1	B2	B5	
35B, CS36C, CS41, CSE385CB, CSE3330, HC31, HC36, HC41, HCS31, HCS36	30	12	3/8" LOW PROFILE	1.3	44	B44	120SDEA318	B1	B2	B5	
	35	14	3/8" LOW PROFILE	1.3	49	B49	140SDEA318	B1	B2	B5	
	40	16	3/8" LOW PROFILE	1.3	55	B55	160SDEA318	B1	B2	B5	
KS33B-SET, PCN-3335, RCS33, RCS35, RCS40, RCS42, RCS1935B2C, RCS-3335C, RCS3535A, RCS3535B, RCS3535CA, RCS3535CB, RCS3535C2, RCS3835T, RCS 3550 Akku, RCS18352C	35	14	3/8" LOW PROFILE	1.3	52	B52	140SDEA041 (1x) 140SDEA041 (2x) 91P052	B1	B2	B5	
RCS3840T, RCS4040CA, RCS4040CB, RCS4240B, RY36CSX40B-0, RY36CSX40B-160	40	16	3/8" LOW PROFILE	1.3	56	B56	160SDEA041 (1x) 160SDEA041 (2x) 91P056	B1	B2	B5	
ECS2040, RCS1935, RCS2340, RCS3540C, RZC3540C	40	16	3/8" LOW PROFILE	1.3	57	B57	160SDEA041	B1	B2	B5	
RCS4046C	46	18	3/8" LOW PROFILE	1.3	62	B62	180SDEA041	B1	B2	B5	
PCN-3840, PCN-4040	40	16	.325"	1.3	66	E66		D1	D2	D5	
PCN-4545, RCS4446C2	45	18	.325"	1.3	72	E72		D1	D2	D5	
SABRE™	31, 33, CS35, S335B, S385B, 205, 3350B	35	14	3/8" LOW PROFILE	1.3	53	B53		B1	B2	B5
SCHEPPACH™	CSP 2540	25	10	3/8" LOW PROFILE	1.3	40	B40	100SDEA041	B1	B2	B5
CSH 2400-160E	40	16	3/8" LOW PROFILE	1.3	56	B56		B1	B2	B5	
CSP 41	40	16	3/8" LOW PROFILE	1.3	57	B57	160SDEA041	B1	B2	B5	
CSH 46	40	16	3/8" LOW PROFILE	1.3	57	B57	160SDEA095	B1	B2	B5	
	45	18	3/8" LOW PROFILE	1.3	62	B62	180SDEA095	B1	B2	B5	
CES 2500, CSE 2500, CSE 2600, CSE 2700	45	18	3/8" LOW PROFILE	1.3	62	B62	180SDEA041	B1	B2	B5	
CSH 58, CSP 5300	50	20	.325"	1.5	78	F78	208PXBK095	D1	D2	D5	
SCHWARZBACH™	SEK 2000	40	16	3/8" LOW PROFILE	1.3	57	B57	160SDEA041	B1	B2	B5
SHARK™	MKS3840	40	16	3/8" LOW PROFILE	1.3	54		160SDEA318	B1	B2	B5
KS1800-40CK	40	16	3/8" LOW PROFILE	1.3	57	B57	160SDEA041	B1	B2	B5	

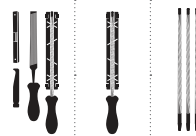
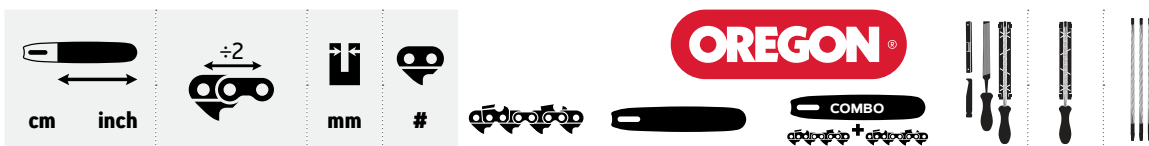

SHINDAIWA™											
250TS, 251TS	25	10	3/8" LOW PROFILE	1.3	40	B40	100SDEA041		B1	B2	B5
PT262S	30	12	3/8" LOW PROFILE	1.3	44	B44	120SDEA041		B1	B2	B5
280TS	25	10	3/8" LOW PROFILE	1.3	40	B40	100SDEA041		B1	B2	B5
	30	12	3/8" LOW PROFILE	1.3	45	B45	120SDEA041 (1x) 120SDEA041 (2x) 91P045		B1	B2	B5
	30	12	3/8" LOW PROFILE	1.3	47				B1	B2	B5
	30	12	3/8" LOW PROFILE	1.3	45	B45	120SDEA041 (1x) 120SDEA041 (2x) 91P045		B1	B2	B5
251WS, 269TS, 305S, 320TS, 352S, 353S, 360, 360TS, 361WS, 362TS, 362WS	30	12	3/8" LOW PROFILE	1.3	47				B1	B2	B5
	35	14	3/8" LOW PROFILE	1.3	52	B52	140SDEA041 (1x) 140SDEA041 (2x) 91P052		B1	B2	B5
	35	14	3/8" LOW PROFILE	1.3	53	B53			B1	B2	B5
	40	16	3/8" LOW PROFILE	1.3	56	B56	160SDEA041 (1x) 160SDEA041 (2x) 91P056		B1	B2	B5
377, 390SX, 431SX	40	16	3/8" LOW PROFILE	1.3	57	B57			B1	B2	B5
	33	13	.325"	1.3	56	D56	130MLBK041		D1	D2	D5
	38	15	.325"	1.3	64	D64	150MLBK041		D1	D2	D5
	40	16	.325"	1.3	66	D66	160MLBK041		D1	D2	D5
	45	18	.325"	1.3	72	D72	180MLBK041		D1	D2	D5
451S* * Chain gauge may vary	33	13	.325"	1.3	56	D56	130MLBK095 (1x) 130MLBK095 (2x) 95TXL056		D1	D2	D5
	38	15	.325"	1.3	64	D64	150MLBK095 (1x) 150MLBK095 (2x) 95TXL064		D1	D2	D5
	45	18	.325"	1.3	72	D72	180MLBK095 (1x) 180MLBK095 (2x) 95TXL072		D1	D2	D5
389S, 405S, 451S*, 452S, 452GS, 488, 488P, 490, 501SX * Chain gauge may vary	33	13	.325"	1.5	56	F56	138PXBK041		D1	D2	D5
	38	15	.325"	1.5	64	F64	158PXBK041		D1	D2	D5
	40	16	.325"	1.5	66	F66	168PXBK041		D1	D2	D5
	45	18	.325"	1.5	72	F72	188VXLGK041		D1	D2	D5
598, 600, 600SX, 601SX, 731SX	40	16	3/8"	1.5	60		168SFHD009		D1	D2	D5
	45	18	3/8"	1.5	68	L68	188SFHD009 (1x) 188SFHD009 (2x) 73DPX068		K1	K2	K5
	50	20	3/8"	1.5	72	L72	208SFHD009 (1x) 208SFHD009 (2x) 73DPX072		K1	K2	K5
SHINGU™											
SP3200T, SP3200, SP3400	30	12	3/8" LOW PROFILE	1.3	45	B45	120SDEA041 (1x) 120SDEA041 (2x) 91P045		B1	B2	B5
	35	14	3/8" LOW PROFILE	1.3	52	B52	140SDEA041 (1x) 140SDEA041 (2x) 91P052		B1	B2	B5
	40	16	3/8" LOW PROFILE	1.3	57	B57	160SDEA041		B1	B2	B5
SKIL™											
1605, 1606, 1607, 1620U, 1634U, 1636U	30	12	3/8" LOW PROFILE	1.3	45	B45	120SDEA041 (1x) 120SDEA041 (2x) 91P045		B1	B2	B5
	35	14	3/8" LOW PROFILE	1.3	52	B52	140SDEA041 (1x) 140SDEA041 (2x) 91P052		B1	B2	B5
	40	16	3/8" LOW PROFILE	1.3	57	B57	160SDEA041		B1	B2	B5
SOLO™ by AL-KO™											
CS 4235 (25 cm)	25	10	3/8" LOW PROFILE	1.1	40	A40			A1	A2	A5
CSA 130MT	25	10	3/8" LOW PROFILE	1.3	40	A40			A1	A2	A5
613, 620, 621, CS 4235	30	12	3/8" LOW PROFILE	1.3	45	B45	120SDEA041 (1x) 120SDEA041 (2x) 91P045		B1	B2	B5
	35	14	3/8" LOW PROFILE	1.3	52	B52	140SDEA041 (1x) 140SDEA041 (2x) 91P052		B1	B2	B5
	40	16	3/8" LOW PROFILE	1.3	57	B57			B1	B2	B5
6238, 6240, 6436, 6442	35	14	3/8" LOW PROFILE	1.3	53	B53	140SDEA041		B1	B2	B5
	40	16	3/8" LOW PROFILE	1.3	57	B57	160SDEA041		B1	B2	B5
614, 630, 633, 635, 635 Eco, 636, 637, 640, 642, 643, CC 1936, CC 2740	30	12	3/8" LOW PROFILE	1.3	45	B45	120SDEA095		B1	B2	B5
	35	14	3/8" LOW PROFILE	1.3	52	B52	140SDEA095		B1	B2	B5
	40	16	3/8" LOW PROFILE	1.3	56	B56	160SDEA095		B1	B2	B5
	40	16	3/8" LOW PROFILE	1.3	57	B57	160SDEA095		B1	B2	B5
639, 641, 643IP, 644, 644 SP, 645, 646, 647, 650, 651, 651C, 651SP, 652, 654, 656*, 656 C*, 656 SP, CC 3045, 3351, 3352, 4051, 4256, 6646, 6651, 6656* * Pitch may vary and be 3/8	33	13	.325"	1.5	56	F56	138PXBK095 (1x) 138PXBK095 (2x) 21BPX056		D1	D2	D5
	38	15	.325"	1.5	64	F64	158PXBK095 (1x) 158PXBK095 (2x) 21BPX064		D1	D2	D5
	40	16	.325"	1.5	66	F66	168PXBK095		D1	D2	D5
	45	18	.325"	1.5	72	F72	188PXBK095 (1x) 188PXBK095 (2x) 21BPX072		D1	D2	D5
656*, 656 C*, 6656* * Pitch may vary and be .325	40	16	3/8"	1.5	60				K1	K2	K5
	45	18	3/8"	1.5	68	L68	188SFHK095		K1	K2	K5
	50	20	3/8"	1.5	72	L72	208VXLHK095		K1	K2	K5



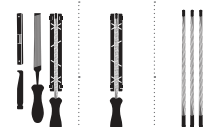
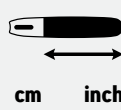

**SOLO™ by AL-KO™ ./. .**

662, 665, 667, 670, 675, 680, 681, 690	38	15	3/8"	1.5	56	<b>73DPX056E</b>	<b>158SFHD009</b>	(1x) <b>158SFHD009</b> (2x) <b>73DPX056</b>	K1	K2	K5
	40	16	3/8"	1.5	60		<b>168SFHD009</b>		K1	K2	K5
	45	18	3/8"	1.5	68	<b>L68</b>	<b>188SFHD009</b>	(1x) <b>188SFHD009</b> (2x) <b>73DPX068</b>	K1	K2	K5
	50	20	3/8"	1.5	72	<b>L72</b>	<b>208SFHD009</b>	(1x) <b>208SFHD009</b> (2x) <b>73DPX072</b>	K1	K2	K5

**STARK™/SYMPRA™/SYMPRATEC™**

1400, 1412, 1430, 14830, 1414, 1435, 14350, 14835, 14840, 1416, 1500, 1600, 1616, 14400, 16840	30	12	3/8" LOW PROFILE	1.3	44	<b>B44</b>	<b>120SDEA318</b>		B1	B2	B5
	35	14	3/8" LOW PROFILE	1.3	49	<b>B49</b>	<b>140SDEA318</b>		B1	B2	B5
	40	16	3/8" LOW PROFILE	1.3	55	<b>B55</b>	<b>160SDEA318</b>		B1	B2	B5

**STARR™**

YT4635	40	16	3/8" LOW PROFILE	1.3	57	<b>B57</b>	<b>160SDEA041</b>		B1	B2	B5
--------	----	----	------------------	-----	----	------------	-------------------	--	----	----	----

**STAYER™**

SEC35, SEC40	35	14	3/8" LOW PROFILE	1.3	50	<b>B50</b>			B1	B2	B5
	40	16	3/8" LOW PROFILE	1.3	56	<b>B56</b>			B1	B2	B5

**STERWINS™**

36 CS Li-2	40	16	3/8" LOW PROFILE	1.1	56	<b>A56</b>	<b>164MLEA041</b>		A1	A2	A5
36 PS Li-2	20	8	3/8" LOW PROFILE	1.3	33	<b>B33</b>			B1	B2	B5
EPS2-20.3	20	8	3/8" LOW PROFILE	1.3	33	<b>B33</b>	<b>080SDEA041</b>		B1	B2	B5
40VPS2-24.1	25	10	3/8" LOW PROFILE	1.3	40	<b>B40</b>	<b>100SDEA041</b>		B1	B2	B5
PCS2-27.3, PCS2-27.31	30	12	3/8" LOW PROFILE	1.3	45	<b>B45</b>	<b>120SDEA041</b>	(1x) <b>120SDEA041</b> (2x) <b>91P045</b>	B1	B2	B5
ECS2-35.3, PCS2-35.3, 40VCS2-34.1	35	14	3/8" LOW PROFILE	1.3	52	<b>B52</b>	<b>140SDEA041</b>	(1x) <b>140SDEA041</b> (2x) <b>91P052</b>	B1	B2	B5
PCS38, PCS2-35.31, PN3800	35	14	3/8" LOW PROFILE	1.3	53	<b>B53</b>	<b>140SDEA041</b>		B1	B2	B5
ECS1-40.3, ECS2-40.3, PCS2-40.3, PCS2-40.31	40	16	3/8" LOW PROFILE	1.3	57	<b>B57</b>	<b>160SDEA041</b>		B1	B2	B5
ECS2-45.3	45	18	3/8" LOW PROFILE	1.3	63	<b>B63</b>	<b>180SDEA041</b>		B1	B2	B5
PCS1-40.3	40	16	.325"	1.5	66	<b>F66</b>	<b>168PXBK095</b>		D1	D2	D5
PCS46, PN4600, PCS1-45.3, PCS1-45.31, PCS2-45.3, PCS2-45.31	45	18	.325"	1.5	72	<b>F72</b>	<b>188PXBK095</b>		D1	D2	D5

**STIGA™**

MP 500, MP 700, PR 700e, PR 730, PS 700e, PS 900e, SMT 500 AE, SPR 255, SPR 276, SPS 700 AE	20	8	3/8" LOW PROFILE	1.3	33	<b>B33</b>	<b>080SDEA041</b>		B1	B2	B5
	25	10	3/8" LOW PROFILE	1.3	40	<b>B40</b>	<b>100SDEA041</b>		B1	B2	B5
	30	12	3/8" LOW PROFILE	1.3	45	<b>B45</b>	<b>120SDEA041</b>	(1x) <b>120SDEA041</b> (2x) <b>91P045</b>	B1	B2	B5
SE 1.6, SE 1.8, SE 182, SP 340	30	12	3/8" LOW PROFILE	1.3	44	<b>B44</b>	<b>120SDEA074</b>	(1x) <b>120SDEA074</b> (2x) <b>91P044</b>	B1	B2	B5
	35	14	3/8" LOW PROFILE	1.3	50	<b>B50</b>	<b>140SDEA074</b>	(1x) <b>140SDEA074</b> (2x) <b>91P050</b>	B1	B2	B5
P382S	40	16	3/8" LOW PROFILE	1.3	56	<b>B56</b>			B1	B2	B5
SPR 500 AE	30	12	3/8" LOW PROFILE	1.3	45	<b>B45</b>	<b>120SDEA041</b>	(1x) <b>120SDEA041</b> (2x) <b>91P045</b>	B1	B2	B5
ES 1814, SE 1835	35	14	3/8" LOW PROFILE	1.3	52	<b>B52</b>	<b>140SDEA041</b>	(1x) <b>140SDEA041</b> (2x) <b>91P052</b>	B1	B2	B5
A 375, A 405, C1.8 E, C1.8 ET, C2.0 E, C2.0 ET, C2.2 E, C2.2 ET, C38, C38T, CP40, CS48Li14, CS700e, EA1800, EA2000Q, EL2416Q, ES 2040, ES 2040T, SC48AE, SE 180, SE 180 Q, SE 190, SE 1814 Q, SE 2016 Q, SE 2216 Q, SEV 2416 Q, SP350, SP352, SP375, SP375 Q, XC 238, XC 240	35	14	3/8" LOW PROFILE	1.3	52	<b>B52</b>	<b>140SDEA041</b>	(1x) <b>140SDEA041</b> (2x) <b>91P052</b>	B1	B2	B5
	40	16	3/8" LOW PROFILE	1.3	57	<b>B57</b>	<b>160SDEA041</b>		B1	B2	B5
CS 118c, CS 122c, ES 1814, ES 2016 Q, ES 2216 Q, SC 80 AE, SE 2240 Q	35	14	3/8" LOW PROFILE	1.3	52	<b>B52</b>	<b>140SDEA041</b>	(1x) <b>140SDEA041</b> (2x) <b>91P052</b>	B1	B2	B5
	40	16	3/8" LOW PROFILE	1.3	56	<b>B56</b>	<b>160SDEA041</b>	(1x) <b>160SDEA041</b> (2x) <b>91P056</b>	B1	B2	B5
A 3700, A 4000, CS 330, CS 540, SP37, SP316, SP372, SP375, SP375Q, SP386	30	12	3/8" LOW PROFILE	1.3	45	<b>B45</b>	<b>120SDEA041</b>	(1x) <b>120SDEA041</b> (2x) <b>91P045</b>	B1	B2	B5
	35	14	3/8" LOW PROFILE	1.3	53	<b>B53</b>	<b>140SDEA041</b>		B1	B2	B5
	40	16	3/8" LOW PROFILE	1.3	57	<b>B57</b>	<b>160SDEA041</b>		B1	B2	B5
CS 545, SP246, SP 370, SP 405 Q, SP 410, SP 426	33	13	.325"	1.3	56	<b>D56</b>	<b>130MLBK041</b>		D1	D2	D5
	38	15	.325"	1.3	64	<b>D64</b>	<b>150MLBK041</b>		D1	D2	D5
	40	16	.325"	1.3	66	<b>D66</b>	<b>160MLBK041</b>		D1	D2	D5
CS 750, CS 755, PS46, PS52, PS460, PS510, SP 466, SP 526	33	13	.325"	1.5	56	<b>F56</b>	<b>138PXBK095</b>	(1x) <b>138PXBK095</b> (2x) <b>21BPX056</b>	D1	D2	D5
	38	15	.325"	1.5	64	<b>F64</b>	<b>158PXBK095</b>	(1x) <b>158PXBK095</b> (2x) <b>21BPX064</b>	D1	D2	D5
	40	16	.325"	1.5	66	<b>F66</b>	<b>168PXBK095</b>		D1	D2	D5
	45	18	.325"	1.5	72	<b>F72</b>	<b>188PXBK095</b>	(1x) <b>188PXBK095</b> (2x) <b>21BPX072</b>	D1	D2	D5
	50	20	.325"	1.5	78	<b>F78</b>	<b>208PXBK095</b>		D1	D2	D5

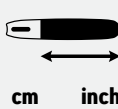
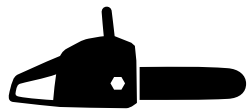

STIHL™	cm	inch	mm	#	A44	124MLEA074	A50	144MLEA074	B44	120SDEA074	(1x) 120SDEA074 (2x) 91P044	B50	140SDEA074	(1x) 140SDEA074 (2x) 91P050	B55	160SDEA074	(1x) 160SDEA074 (2x) 91P055	B45	120SDEA074	B56	160SDEA074	D56	95TXL062E	MS 251C-BE*	MS 261, MS 261C-BM, MS 261C-M, MS 261C-M VW, MS 271, MS 271C-BE, MSA 300, MSA 300 C-O	MS 231*, MS 241*, MS 241C-M*, MS 251*	MS 231C-BE*, MS 251C-BE, MS 251C-BEQ*	O32*, O34*, O36*, O39*, MS 240, MS 260, MS 260 C-B, MS 260-W, MS 260-DW, MS 260 C-BW, MS 261, MS 261C-BE, MS 261C-Q, MS 261C-M, MS 261C-M VW, MS 261C-BM, MS 261-VW, MS 270, MS 270 C-B, MS 271, MS 271C-BE, MS 280, MS 280 C-B, MS 280 C-BQ, MS 280 I, MS 280 C-BI, MS 280 C-BQI, MS 291*, MS 360*, MSA 300
HT 56, HT 70, HT 75, HT 100, HT 101**, HT 130, HT 131**, HTE 60 **Gauge may vary	30	12	3/8" LOW PROFILE	1.1	44	A44	124MLEA074																					
009, 017, 019, 019T, 023L, E14, E140, MS 170, MS 170-D, MS 171, MS 180**, MS 180 C-BD**, MS 180 C-BE**, MS 181**, MS 181C-BE**, MS 190**, MS 190T**, MS 192, MS 192C-E**, MS 192T**, MS 193 C-E**, MS 194 C-E, MS 200T**, MS 201T**, MSE 140**, MSE 140 C-BQ, MSE 141, MSE 141C, MSE 141C-Q, MSE 170**, MSE 170C-Q, MSE 170C-BQ ** 1.1 mm gauge as from year 2014. 1.3 mm gauge until year 2013. *** Gauge may vary	30	12	3/8" LOW PROFILE	1.1	44	A44	124MLEA074																					
009, 010, 011, 012, 015, 018/CQT, 020, 020T, 021/CQT, 023/C, 023/CQT, 025, AV Electronic, E10, E14, E160, E180/CQT, HT 101**, HT 131**, MS 180**, MS 180 C-BD**, MS 180 C-BE**, MS 181**, MS 181C-BE**, MS 190**, MS 190T**, MS 191, MS 191T, MS 192C-E**, MS 192T**, MS 192TC-E, MS 193 C-E**, MS 193T, MS 200, MS 200T**, MS 201, MS 201C-M, MS 201T**, MS 201TC-M, MS 210, MS 210 C-BE, MS 210 C-BQ, MS 211, MS 211C-BE, MS 230, MS 230 C-BE, MS 231*, MS 231C-BE*, MS 241*, MS 241C-BEM*, MS 241C-M*, MS 241C-MQ*, MS 241C-M VW*, MS 250, MS 250 C-BE, MS 251*, MS 251C-BE*, MSA 220 C-B, MSA 220 T, MSA 220 TC-O, MSE 140**, MSE 160, MSE 160 C-BQ, MSE 170**, MSE 180, MSE 180 C-BQ, MSE 190 C-B, MSE 190C-Q, MSE 190C-BQ, MSE 200, MSE 200 C-BQ, MSE 210, MSE 230 * Chain pitch and/or gauge may vary by year ** 1.3 mm gauge until year 2013. 1.1 mm gauge as from year 2014 *** Gauge may vary	30	12	3/8" LOW PROFILE	1.3	44	B44	120SDEA074	(1x) 120SDEA074 (2x) 91P044	B1	B2	B5																	
	35	14	3/8" LOW PROFILE	1.1	50	A50	144MLEA074																					
	40	16	3/8" LOW PROFILE	1.1	55																							
	35	14	3/8" LOW PROFILE	1.3	50	B50	140SDEA074	(1x) 140SDEA074 (2x) 91P050	B1	B2	B5																	
	40	16	3/8" LOW PROFILE	1.3	55	B55	160SDEA074	(1x) 160SDEA074 (2x) 91P055	B1	B2	B5																	
MSE 210 C-B, MSE 210 C-BQ, MSE 230 C-B, MSE 230 C-BQ Above models with rapid chain tensioner & 7-tooth sprocket take an extra drive link	30	12	3/8" LOW PROFILE	1.3	45	B45	120SDEA074																					
	35	14	3/8" LOW PROFILE	1.3	51		140SDEA074																					
	40	16	3/8" LOW PROFILE	1.3	56	B56	160SDEA074																					
MS 251* * Chain pitch and/or gauge may vary by year	35	14	.325"	1.3	56	D56																						
	40	16	.325"	1.3	62	95TXL062E																						
MS 251C-BE* * Chain pitch and gauge may vary by year	35	14	.325"	1.3	57																							
	40	16	.325"	1.3	63																							
	35	14	.325"	1.3	60	95TXL060E																						
MS 261, MS 261C-BM, MS 261C-M, MS 261C-M VW, MS 271, MS 271C-BE, MSA 300, MSA 300 C-O New fit up as from 2020	38	15	.325"	1.3	62	95TXL062E	150TXLGD025																					
	40	16	.325"	1.3	67	95TXL067E	160TXLGD025																					
	45	18	.325"	1.3	74	95TXL074E	180TXLGD025																					
	35	14	.325"	1.6	56																							
MS 231*, MS 241*, MS 241C-M*, MS 251* * Chain pitch and/or gauge may vary by year	40	16	.325"	1.6	62	G62	163PXBA074	(1x) 163PXBA074 (2x) 22BPX062																				
	45	18	.325"	1.6	68	G68	183PXBA074																					
	35	14	.325"	1.6	57																							
MS 231C-BE*, MS 251C-BE, MS 251C-BEQ* * Chain pitch and/or gauge may vary by year	40	16	.325"	1.6	63																							
	45	18	.325"	1.6	68	G68	183PXBA074																					
	33	13	.325"	1.6	56																							
O32*, O34*, O36*, O39*, MS 240, MS 260, MS 260 C-B, MS 260-W, MS 260-DW, MS 260 C-BW, MS 261, MS 261C-BE, MS 261C-Q, MS 261C-M, MS 261C-M VW, MS 261C-BM, MS 261-VW, MS 270, MS 270 C-B, MS 271, MS 271C-BE, MS 280, MS 280 C-B, MS 280 C-BQ, MS 280 I, MS 280 C-BI, MS 280 C-BQI, MS 291*, MS 360*, MSA 300 * Chain pitch may vary by year	38	15	.325"	1.6	62	G62	153SFGD025	(1x) 153SFGD025 (2x) 22BPX062																				
	40	16	.325"	1.6	67	G67	163SFGD025	(1x) 163SFGD025 (2x) 22BPX067																				
	45	18	.325"	1.6	74	G74	183SFGD025	(1x) 183SFGD025 (2x) 22BPX074																				
	50	20	.325"	1.6	81																							



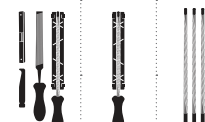
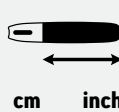
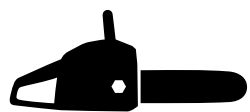

STIHL™ ./.	cm	inch		mm	#						
029, 031, 032*, 034*, 036*, 038, 039*, 041, 042, 044, 045, 046, 048, 056, 064, 066, MS 290, MS 291*, MS 310, MS 311, MS 340, MS 341, MS 360*, MS 361, MS 361C-B, MS 361C-BQ, MS 361C-Q, MS 361-W, MS 361-VW, MS 362, MS 362C-B, MS 362C-Q, MS 362C-M, MS 362C-MQ, MS 362C-MVW, MS 362V-W, MS 390, MS 391, MS 400C-M, MS 440, MS 440-D, MS 440-W, MS 441, MS 441C-M, MS 441C-MW, MS 441-W, MS 441C-Q, MS 460, MS 460-D, MS 460-W, MS 461, MS 462C-M, MS 462C-MVW, MS 500i, MS 500iW, MS 650, MS 660, MS 660-W, MS 661, MS 661C-M, MS 661C-MVW, MSE 220C-Q**, MSE 250, MSE 250C-BQ * Chain pitch may vary by year ** 57 drive link for 15" bar	38	15	3/8"	1.6	56		153SFHD025		K1	K2	K5
	40	16	3/8"	1.6	60	M60	163SFHD025 (1x) 163SFHD025 (2x) 75DPX060		K1	K2	K5
	45	18	3/8"	1.6	66	M66	183SFHD025 (1x) 183SFHD025 (2x) 75DPX066		K1	K2	K5
	50	20	3/8"	1.6	72	M72	203SFHD025 (1x) 203SFHD025 (2x) 75DPX072		K1	K2	K5
<b>SWING™</b>											
1640 KS	40	16	3/8" LOW PROFILE	1.3	56	B56			B1	B2	B5
1640KS, EKS1600, EKS1640	40	16	3/8" LOW PROFILE	1.3	57	B57	160SDEA041		B1	B2	B5
EKS1800 / 1840	40	16	3/8" LOW PROFILE	1.3	57	B57			B1	B2	B5
<b>TALON™</b>											
	30	12	3/8" LOW PROFILE	1.3	45	B45			B1	B2	B5
	35	14	3/8" LOW PROFILE	1.3	49	B49			B1	B2	B5
	35	14	3/8" LOW PROFILE	1.3	52	B52	140SDEA095		B1	B2	B5
AC2108, AC2109, AC2101, AC2105	40	16	3/8" LOW PROFILE	1.3	54				B1	B2	B5
	40	16	3/8" LOW PROFILE	1.3	55	B55	160SDEA318		B1	B2	B5
	40	16	3/8" LOW PROFILE	1.3	56	B56			B1	B2	B5
	45	18	3/8" LOW PROFILE	1.3	60				B1	B2	B5
AC3101-35, AC2111, AC310114-35, CS38	35	14	3/8" LOW PROFILE	1.3	49	B49	140SDEA318		B1	B2	B5
AC3102	40	16	.325"	1.3	66	E66			D1	D2	D5
	45	18	.325"	1.3	72	E72			D1	D2	D5
<b>TAS TANAKA™</b>											
TCS2801S	25	10	3/8" LOW PROFILE	1.3	40	B40			B1	B2	B5
	30	12	3/8" LOW PROFILE	1.3	45	B45	120SDEA041 (1x) 120SDEA041 (2x) 91P045		B1	B2	B5
290, 300, ECS3351, ECS330, ECS3500, ECS360, ECS320, ECS3301, TCS3401, TCS3301S	35	14	3/8" LOW PROFILE	1.3	52	B52	140SDEA041 (1x) 140SDEA041 (2x) 91P052		B1	B2	B5
	40	16	3/8" LOW PROFILE	1.3	57	B57	160SDEA041		B1	B2	B5
TCS3801	38	15	.325"	1.3	64	D64			D1	D2	D5
<b>TITAN™</b>											
TTL488GDO, TTK587GDO, TTL650GDO	20	8	3/8" LOW PROFILE	1.3	33	B33	080SDEA041		B1	B2	B5
TTCS25	25	10	3/8" LOW PROFILE	1.3	40	B40	100SDEA041		B1	B2	B5
TTB355CHN, YT4359	40	16	3/8" LOW PROFILE	1.3	56	B56	160SDEA041 (1x) 160SDEA041 (2x) 91P056		B1	B2	B5
TTL759CHN	40	16	3/8" LOW PROFILE	1.3	57	B57	160SDEA041		B1	B2	B5
TTCS25	45	18	3/8" LOW PROFILE	1.3	61	B61	180SDEA095		B1	B2	B5
TTL760CHN	50	20	.325"		78	F78	208PXBK095		D1	D2	D5
<b>TONINO LAMBORGHINI™</b>											
KS 6024	40	16	3/8" LOW PROFILE	1.3	57	B57	160SDEA041		B1	B2	B5
<b>TOOM™</b>											
EKS 1635, EKS 1840	35	14	3/8" LOW PROFILE	1.3	52	B52	140SDEA041 (1x) 140SDEA041 (2x) 91P052		B1	B2	B5
ECS2000-40	40	16	3/8" LOW PROFILE	1.3	56	B56			B1	B2	B5
	40	16	3/8" LOW PROFILE	1.3	57	B57			B1	B2	B5
EKS 1840	40	16	3/8" LOW PROFILE	1.3	57	B57	160SDEA041		B1	B2	B5
<b>TOP-CRAFT™</b>											
E1.7Profi, 2000, EKS 1700	40	16	3/8" LOW PROFILE	1.1	55				A1	A2	A5
KTKS 1,8 PRO	40	16	3/8" LOW PROFILE	1.3	55	B55	160SDEA318		B1	B2	B5
2000	40	16	3/8" LOW PROFILE	1.3	55	B55			B1	B2	B5
KSI2000-40, KSI2100, KSI2200	40	16	3/8" LOW PROFILE	1.3	56	B56	160SDEA041 (1x) 160SDEA041 (2x) 91P056		B1	B2	B5
EKS 1700, EKS1751-40, 1800, EKS 1800-40	40	16	3/8" LOW PROFILE	1.3	57	B57	160SDEA041		B1	B2	B5
EKS 1750, TCK 1640 (2001)	40	16	3/8" LOW PROFILE	1.3	57	B57			B1	B2	B5

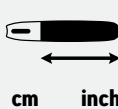
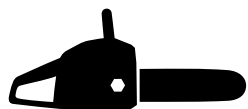

**TURBO SILENT™**

BKS2335	35	14	3/8" LOW PROFILE	1.3	52	<b>B52</b>			B1	B2	B5
BKS3536, BKS3536-II	35	14	3/8" LOW PROFILE	1.3	52	<b>B52</b>	<b>140SDEA041</b>	(1x) <b>140SDEA041</b> (2x) <b>91P052</b>	B1	B2	B5
BKS4041, BKS4041-II	40	16	3/8" LOW PROFILE	1.3	56	<b>B56</b>			B1	B2	B5
EKS 2040	40	16	3/8" LOW PROFILE	1.3	57	<b>B57</b>	<b>160SDEA041</b>		B1	B2	B5
BKS4245	45	18	3/8" LOW PROFILE	1.3	60		<b>180SDEA318</b>		B1	B2	B5

**UNIROPA™**

PKS 35	35	14	3/8" LOW PROFILE	1.3	52	<b>B52</b>			B1	B2	B5
--------	----	----	------------------	-----	----	------------	--	--	----	----	----

**VAP™**

1400, 35F, 38, 40F, 44F, 52F, 530, 534, 535, 538, 60F	30	12	3/8" LOW PROFILE	1.3	44	<b>B44</b>			B1	B2	B5
	35	14	3/8" LOW PROFILE	1.3	49	<b>B49</b>			B1	B2	B5
	40	16	3/8" LOW PROFILE	1.3	56	<b>B56</b>			B1	B2	B5
14F, 542, 68F	33	13	.325"	1.5	56	<b>F56</b>	<b>138PXBK095</b>	(1x) <b>138PXBK095</b> (2x) <b>21BPX056</b>	D1	D2	D5
	38	15	.325"	1.5	64	<b>F64</b>	<b>158PXBK095</b>	(1x) <b>158PXBK095</b> (2x) <b>21BPX064</b>	D1	D2	D5
	40	16	.325"	1.5	66	<b>F66</b>			D1	D2	D5
	45	18	.325"	1.5	72	<b>F72</b>	<b>188PXBK095</b>	(1x) <b>188SFGK095</b> (2x) <b>21BPX072</b>	D1	D2	D5

**VARIOLUX™**

Pole Saw V-ASA 24	20	8	3/8" LOW PROFILE	1.1	33	<b>A33</b>			A1	A2	A5
Pole Saw V-ASAH 40/20	20	8	3/8" LOW PROFILE	1.3	33	<b>B33</b>			B1	B2	B5
2135KSE, 2140KSE, 2335BKS, BKS 40.1/40	35	14	3/8" LOW PROFILE	1.3	52	<b>B52</b>			B1	B2	B5
	40	16	3/8" LOW PROFILE	1.3	57	<b>B57</b>			B1	B2	B5
2340BKS	40	16	3/8" LOW PROFILE	1.3	56	<b>B56</b>			B1	B2	B5
2340KSE, CBKS 38	40	16	3/8" LOW PROFILE	1.3	56	<b>B56</b>	<b>160SDEA041</b>	(1x) <b>160SDEA041</b> (2x) <b>91P056</b>	B1	B2	B5
2340KSE, V-EKS2200-40, V-EKS2400, V-EKS 2400-40, V-BUS45, KGO-0,38/ V-EKS 2200, KGO-0,48/ V-EKS 2200-40	40	16	3/8" LOW PROFILE	1.3	57	<b>B57</b>	<b>160SDEA041</b>		B1	B2	B5
V-BKS 42-45, V-BKS 46, V-BKS 46-45; BKS46.4/45 Remark: original chain	45	18	3/8" LOW PROFILE	1.3	61	<b>B61</b>			B1	B2	B5
V-BKS 45, V-BKS42-45, V-BKS 46, V-BKS 46-45	45	18	3/8" LOW PROFILE	1.3	62	<b>B62</b>			B1	B2	B5

**VICTUS™**

VT36	35	14	3/8" LOW PROFILE	1.3	52	<b>B52</b>	<b>140SDEA041</b>	(1x) <b>140SDEA041</b> (2x) <b>91P052</b>	B1	B2	B5
VT40,VT200E	40	16	3/8" LOW PROFILE	1.3	56	<b>B56</b>	<b>160SDEA074</b>		B1	B2	B5
VT51	45	18	.325"	1.5	72	<b>F72</b>	<b>188PXBK095</b>		D1	D2	D5

**WESTFALIA™**

Pole Saw	20	8	3/8" LOW PROFILE	1.1	33	<b>A33</b>			A1	A2	A5
----------	----	---	------------------	-----	----	------------	--	--	----	----	----

**WOLF™**

CSE2035	35	14	3/8" LOW PROFILE	1.3	52	<b>B52</b>	<b>140SDEA041</b>	(1x) <b>140SDEA041</b> (2x) <b>91P052</b>	B1	B2	B5
CSB3835	35	14	3/8" LOW PROFILE	1.3	53	<b>B53</b>	<b>140SDEA041</b>		B1	B2	B5
CSB4640	40	16	3/8" LOW PROFILE	1.3	55	<b>B55</b>			B1	B2	B5
CSE2240	40	16	3/8" LOW PROFILE	1.3	57	<b>B57</b>	<b>160SDEA041</b>		B1	B2	B5

**WOODSHARK™**

2275	35	14	3/8" LOW PROFILE	1.3	52	<b>B52</b>	<b>140SDEA041</b>	(1x) <b>140SDEA041</b> (2x) <b>91P052</b>	B1	B2	B5
------	----	----	------------------	-----	----	------------	-------------------	--	----	----	----

**WORX™**

WG349E, WG349E.9	20	8	3/8" LOW PROFILE	1.1	33	<b>A33</b>	<b>084MLEA041</b>		A1	A2	A5
WG322, WG322.9, WG322E.1, WG322E.9, WG323, WG323.9	25	10	3/8" LOW PROFILE	1.1	40	<b>A40</b>			A1	A2	A5
WG381, WG381E, WG381E.1, WG381.9	30	12	3/8" LOW PROFILE	1.1	45	<b>A45</b>	<b>124MLEA041</b>		A1	A2	A5
WG384, WG384.9, WG384E.9, WG384E9	35	14	3/8" LOW PROFILE	1.1	52	<b>A52</b>	<b>144MLEA041</b>		A1	A2	A5
WG385E, WG385.9	40	16	3/8" LOW PROFILE	1.1	56	<b>A56</b>	<b>164MLEA041</b>		A1	A2	A5
WG305, WG305E, WG305.1, WG305.2	35	14	3/8" LOW PROFILE	1.3	52	<b>B52</b>	<b>140SDEA041</b>	(1x) <b>140SDEA041</b> (2x) <b>91P052</b>	B1	B2	B5
WG303, WG303E, WG303.1	40	16	3/8" LOW PROFILE	1.3	56	<b>B56</b>	<b>160SDEA041</b>	(1x) <b>160SDEA041</b> (2x) <b>91P056</b>	B1	B2	B5
	40	16	3/8" LOW PROFILE	1.3	57	<b>B57</b>			B1	B2	B5

**XPERT PERFORMANCE™**

1403-002	40	16	3/8" LOW PROFILE	1.3	57	<b>B57</b>	<b>160SDEA041</b>		B1	B2	B5
----------	----	----	------------------	-----	----	------------	-------------------	--	----	----	----

**YARD FORCE™**

Akku C35	35	14	3/8" LOW PROFILE	1.1	52	<b>A52</b>			A1	A2	A5
----------	----	----	------------------	-----	----	------------	--	--	----	----	----



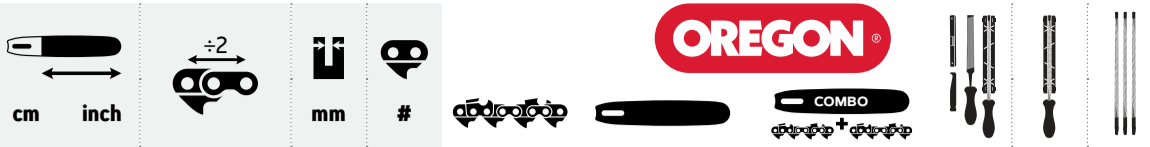

**ZENOAH™**

Model	cm	inch	Profile	Pitch	#	Chain Type	Part Number	Accessories	Links	Links	Links
G25000PS, G2501T	25	10	3/8" LOW PROFILE	1.3	40	B40	100SDEA041		B1	B2	B5
GZ2700T, GZ2800T	30	12	3/8" LOW PROFILE	1.3	45	B45	120SDEA041	(1x) 120SDEA041 (2x) 91P045	B1	B2	B5
	30	12	3/8" LOW PROFILE	1.3	45	B45	120SDEA041	(1x) 120SDEA041 (2x) 91P045	B1	B2	B5
G300T/S, G310TS, G320 AVS	35	14	3/8" LOW PROFILE	1.3	52	B52	140SDEA041	(1x) 140SDEA041 (2x) 91P052	B1	B2	B5
	40	16	3/8" LOW PROFILE	1.3	56	B56	160SDEA041	(1x) 160SDEA041 (2x) 91P056	B1	B2	B5
G3300EZ	35	14	3/8" LOW PROFILE	1.3	52	B52	140SDEA041	(1x) 140SDEA041 (2x) 91P052	B1	B2	B5
	40	16	3/8" LOW PROFILE	1.3	57	B57	160SDEA041		B1	B2	B5
G415AVS, G3802, G3802EZ, G4100, G4101	33	13	.325"	1.3	56	D56			D1	D2	D5
	38	15	.325"	1.3	64	D64			D1	D2	D5
	45	18	.325"	1.3	72	D72			D1	D2	D5
G380AVS	33	13	.325"	1.5	56	F56			D1	D2	D5
	38	15	.325"	1.5	64	F64			D1	D2	D5
G410AVS, G455AVS, G500AVS, G38, G46, G455AVS, G500AVS, G4500, G4501, G5200, G5201, G5201P	33	13	.325"	1.5	56	F56	138PXBK095	(1x) 138PXBK095 (2x) 21BPX056	D1	D2	D5
	38	15	.325"	1.5	64	F64	158PXBK095	(1x) 158PXBK095 (2x) 21BPX064	D1	D2	D5
	40	16	.325"	1.5	66	F66			D1	D2	D5
	45	18	.325"	1.5	72	F72	188PXBK095	(1x) 188SFGK095 (2x) 21BPX072	D1	D2	D5
G621AVS	40	16	3/8"	1.5	60				K1	K2	K5
	45	18	3/8"	1.5	64	73DPX064E			K1	K2	K5



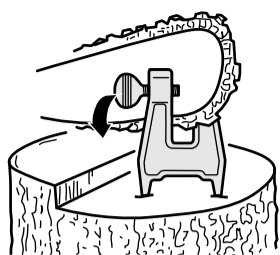

26368A



B4 



557849

585015

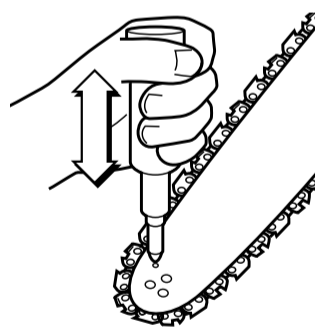

Q39920

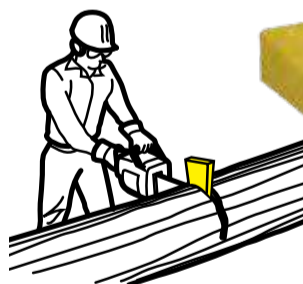

561109

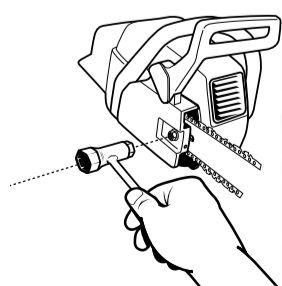

BOSCH™  
CHAMPION™  
NGK™  
DENSKO™

...



# A041 - K041 - T041

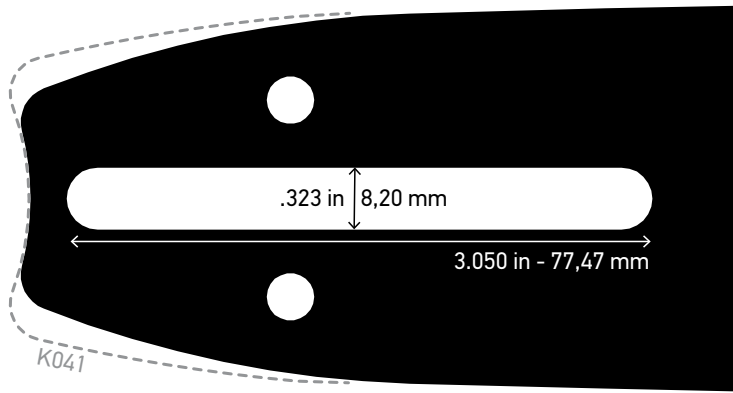

**OEM Applications:** AEG, Active, AL-KO, Alpina, Black+Decker, Bosch, Castor, Cub Cadet®, Dolmar, Draper, Echo®, Efco®, Einhell®, Gardena, Greenworks, Grizzly, Hecht, Hitachi, Homelite®, Husqvarna®, Ikra, Iseki, Jonsered®, Makita®, McCulloch®, MTD, Oleo-Mac®, Partner, Poulan®/Poulan Pro®, Ryobi®, Shindaiwa, Skil®, Solo, Stiga, Tanaka®, Zenoah®, **and others**

# A095 - K095 - Z095\*

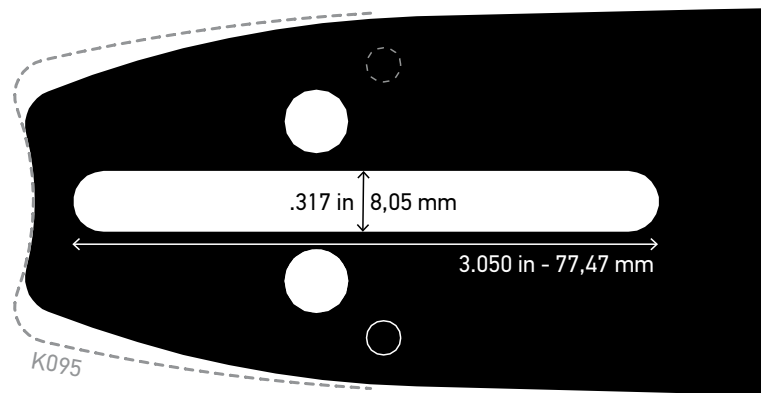

**\*Note:** In a few cases where two bars would have the same called length but different drive-link counts, the letter Z will be used in the motor-mount description to distinguish between them (K095 and Z095 for example).

**OEM Applications:** AL-KO, Alpina, Castor, Cub Cadet®, Dolmar, Efco®, Einhell®, Hecht, Homelite®, Husqvarna®, Jonsered®, Makita®, McCulloch®, Metabo®, Mitox, MTD, Oleo-Mac®, Partner, Pioneer, Poulan®/Poulan Pro®, Ryobi®, Shindaiwa, Solo®, Stiga®, Zenoah®, **and others**

# A074

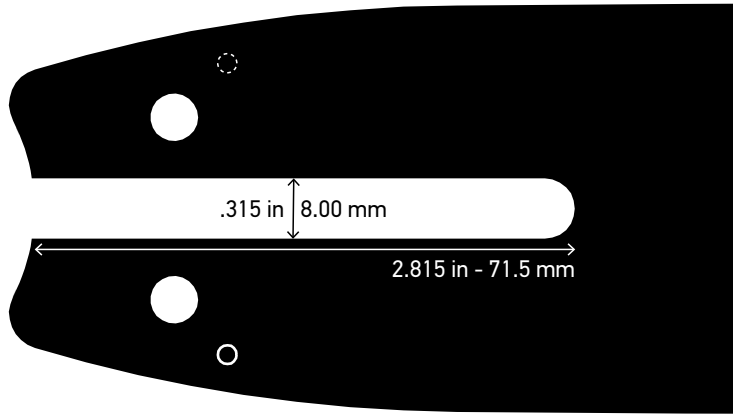

**OEM Applications:** Alpina, Castor, Metabo®, Oleo-Mac®, Stiga®, Stihl®

# A318

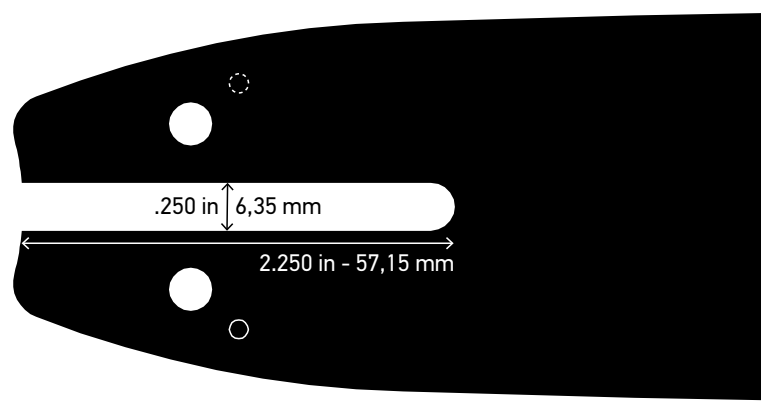

**OEM Applications:** AL-KO, Black+Decker®, Dolmar, Echo®, Efco®, Einhell®, Grizzly, McCulloch®, Oleo-Mac®, Ryobi®, Shindaiwa, Stiga®, **and others**

# D009

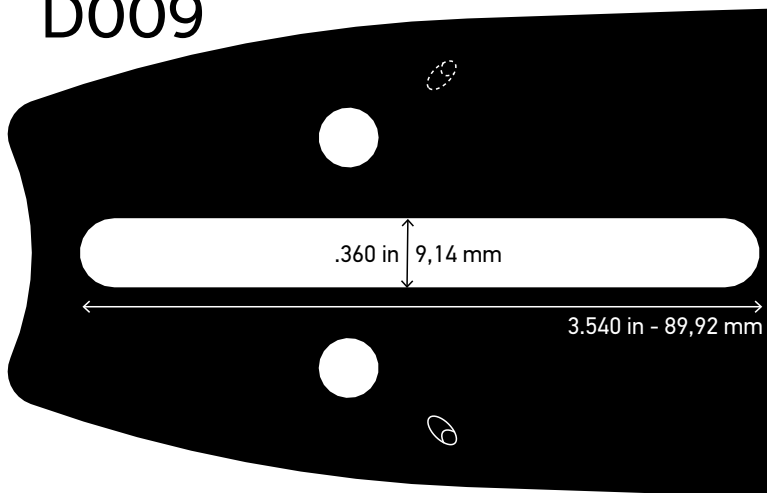

**Note:** VXL have oval holes and shorter slots

**OEM Applications:** Alpina, AL-KO, Dolmar, Efco®, Husqvarna®, Iseki, Jonsered®, Makita®, Oleo-Mac®, Partner, Shindaiwa, Solo®

# D025

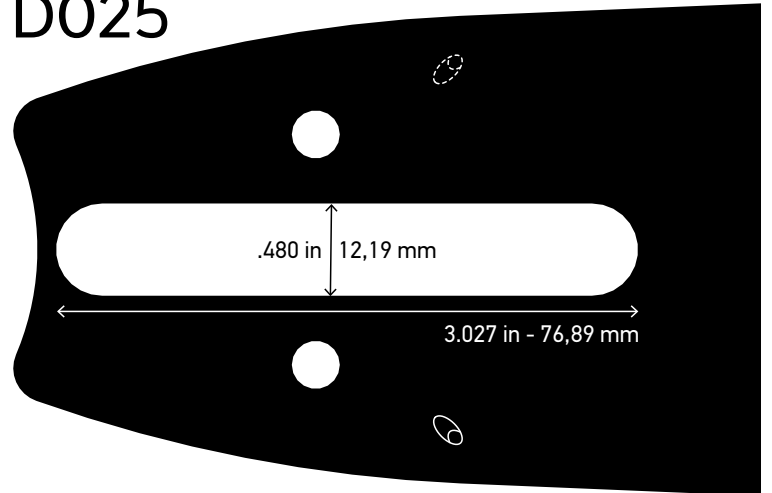

**OEM Applications:** AEG, Stihl®



4,0 mm

**B5**

4,5 mm

**A5**

4,8 mm

**D5**

5,5 mm

**K5**





	= M	75DPX	1,6 mm
	= L	73DPX	1,5 mm
	= G	22BPX	1,6 mm
	= F	21BPX	1,5 mm
	= E	20BPX	1,3 mm
	= D	95T XL	1,3 mm
	= B	91PX	1,3 mm
	= A	90PX	1,1 mm

